

IMMS-CI-HW

Communications Controller Interface

Installation Instructions

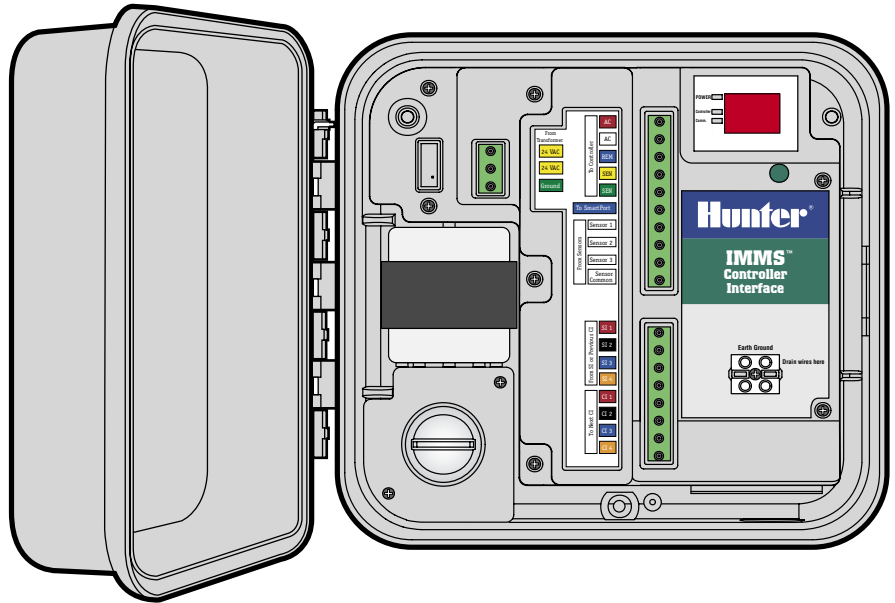

Hunter[®]

TABLE OF CONTENTS

Mount the Cabinet	1
Connect AC power	2
Connect Interface to Controller	3
Connect Interface to ICC	3
Connect Interface to Pro-C and SRC	4
Hardwire connection (IMMS-CI-HW)	5
Wireless Connection	5
Earth Grounding	6
Power and Test	7
Green Button	7
To Address Controller Interfaces	8
Diagnostic Mode	8
Interface Reset	9
Additional Connections	9
Connections to Other Interfaces	9
Connection to optional Clik sensors	10
Powered sensors	10
Wireless Rain-Clik™	11
Flow-Clik IMMS	12
Connection to optional remote receiver (SRR or ICR)	13
GCBL	14
5 conductor sprinkler wire	14

MOUNT THE CABINET.....

Choose a dry, flat location on a suitable indoor or outdoor wall, which will not receive spray from sprinklers. Drive self-tapping screws through recessed holes in plastic cabinet back into solid surface. Ambient operating temperature must not exceed 120°F (50°C).

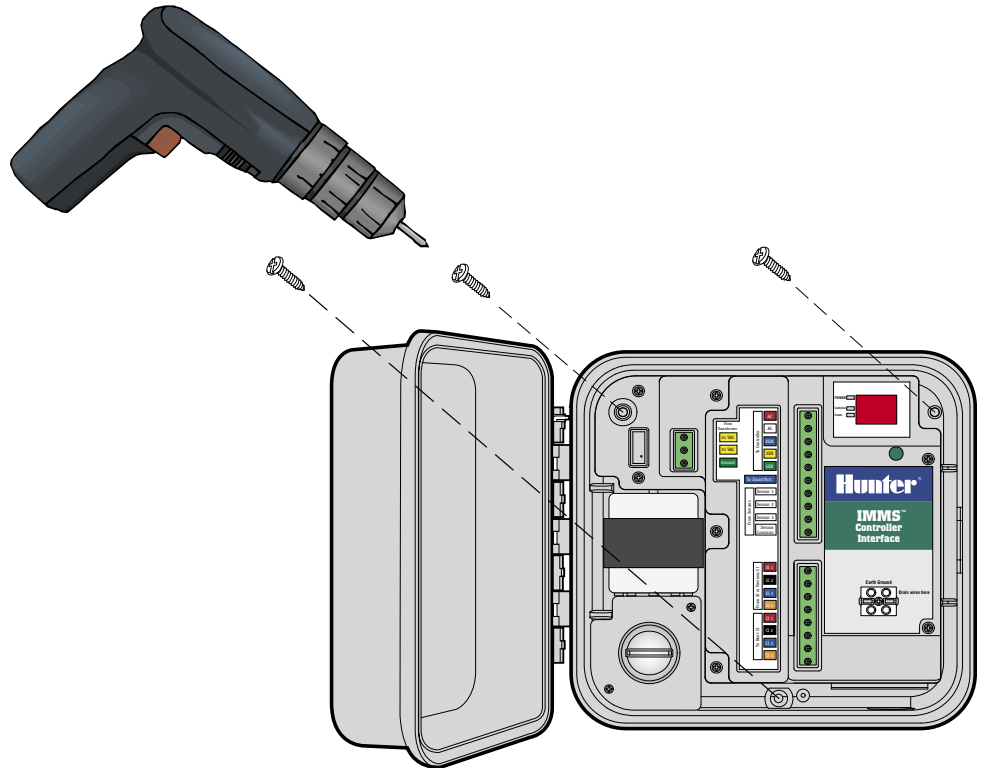

CONNECT AC POWER

1. Verify that AC power is switched OFF at the power source before beginning.
2. Remove the junction box cover (two screws).
3. Use appropriate electrical conduit and fittings to route AC power wire into the junction box. Run high voltage power wiring in separate conduit from low voltage signal wiring.
4. Connect the power wires to the transformer wires with wire nuts (see color code chart), and replace junction box cover.
5. Installer is responsible for local electrical codes and wiring.

Transformer	Hot	Neutral	Safety Ground (required)
North America (115VAC)	Black	White	Green
International (230VAC)	Brown	Blue	Green with yellow stripe

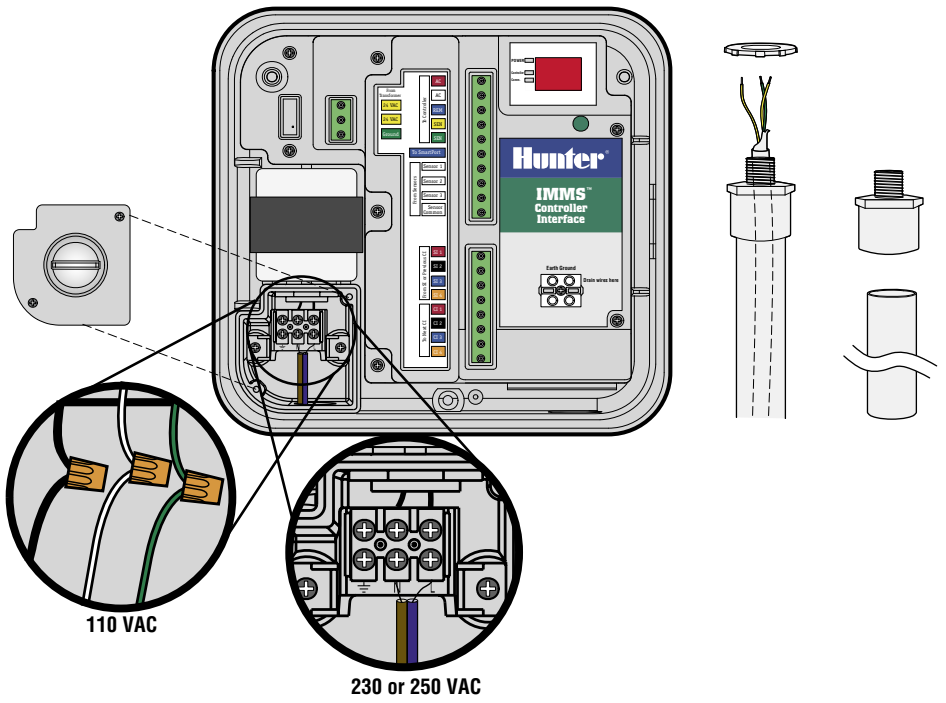

CONNECT INTERFACE TO CONTROLLER.....

1. Use approximately 6 ft. (2 m) of 18 AWG (1 mm) 5-conductor sprinkler wire to connect interface to the controller.
2. Strip wires approximately 3/16" (4.5 mm) and attach to interface, by color, at the "To Controller" section of the terminal strips.
3. Route wire (in separate conduit from AC power) to the controller.

CONNECT INTERFACE TO ICC.....

With controller power OFF, strip wire ends approximately 1/4" (6 mm) and connect by color code to the ICC power module terminals as shown.

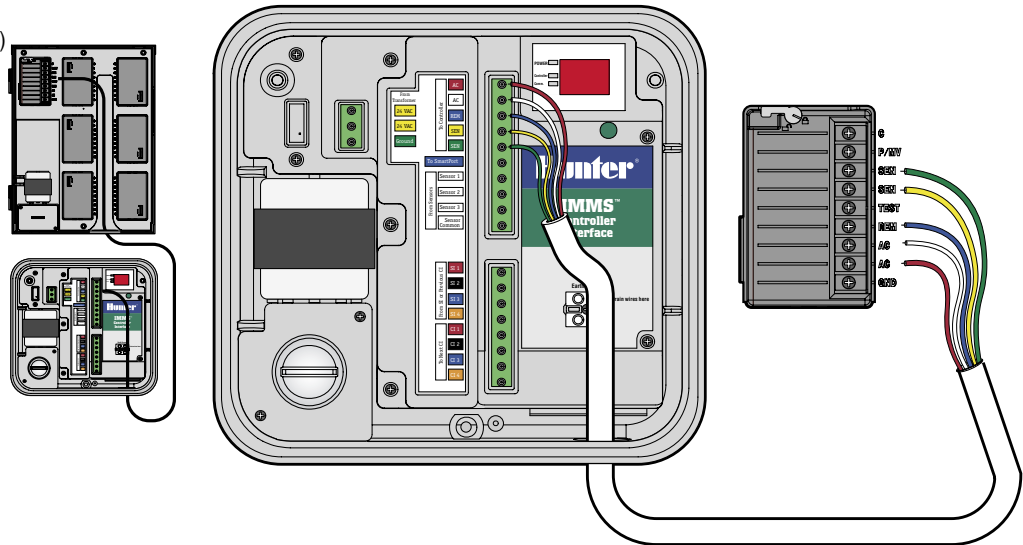

CONNECT INTERFACE TO PRO-C AND SRC.....

With controller power OFF, strip wire ends approximately ¼" (6 mm) and connect by color code to the terminals in the wiring compartment as shown.

To SRC (not shown) With controller power OFF, strip wire ends approximately ¼" (6 mm) and connect by color code to the terminals in the wiring compartment

It is important to connect the red and white wires to the correct AC terminals!

Red	AC (lower AC power terminal, or leftmost terminal in SRC)
White	AC (upper AC power terminal)
Blue	Rem (Remote)
Yellow	Sen (Sensor)
Green	Sen (Sensor)

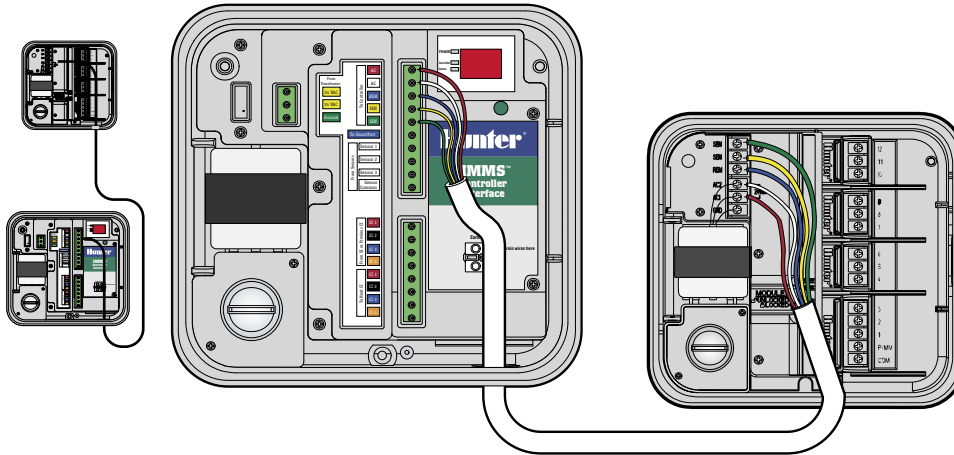
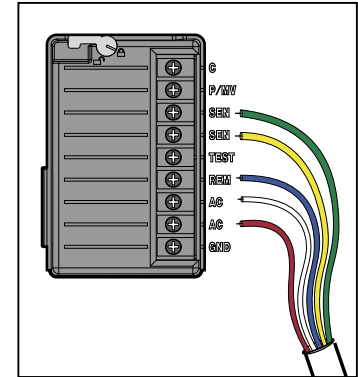
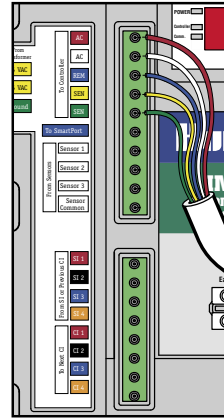

HARDWIRE CONNECTION (IMMS-CI-HW)

IMMS-CI has hardwired input over GCBL cable, from either the Site Interface (SI), or a previous CI. If IMMS-CI will have radio communications, refer to instructions with IMMS-R radio option.

1. Route GCBL cable from SI direction through low-voltage conduit into CI.
2. Strip black outer jacket and excess foil shield back approximately 2" (50 mm).
3. Strip approximately $\frac{3}{16}$ " (4.5 mm) from each individual wire and connect to top half of communications terminals, in area labeled "From SI or Previous CI", observing color codes.
4. Connect bare silver ground wire in GCBL to ground lug at earth ground symbol.
5. Connect bare copper 10 AWG (2.5 mm dia.) wire from ground lug to proper earth ground (recommended impedance 10 Ohms or less).

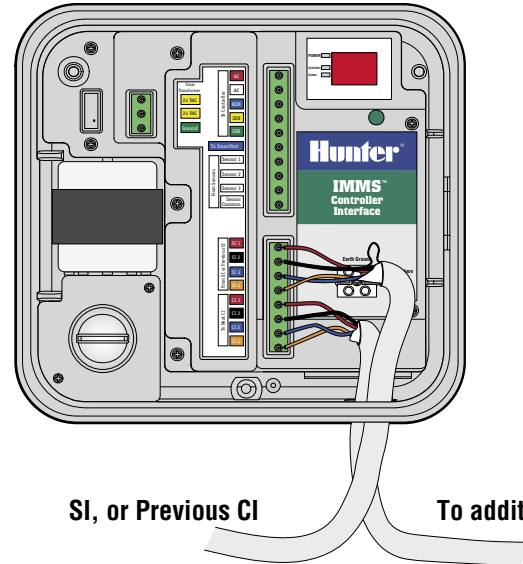

WIRELESS CONNECTION

Refer to instructions included with the optional wireless kit.

EARTH GROUNDING.....

1. Connect bare copper 10 AWG (2.5 mm) Earth Ground wire to grounding terminal where labeled in interface.
2. Route ground wire through low-voltage conduit and secure to 8 ft. (2.5 m) copper-clad ground rod, driven vertically into earth.
3. Ground connection should have recommended resistance of 10 Ohms or less.

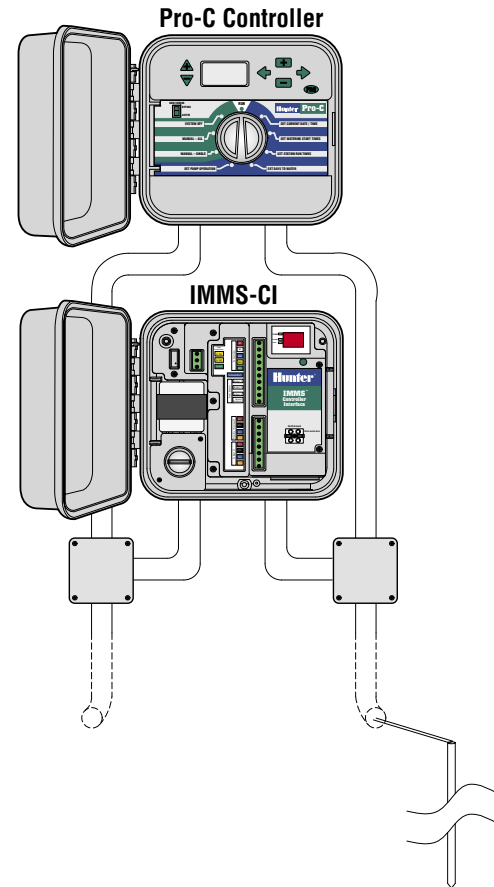

POWER AND TEST.....

Basic connections are complete after these steps. Apply AC power to the interface and observe display. Display should automatically show test pattern, then version number, and then dashes (--). Blinking red dot shows normal operation. No dot, or constant-on dot, means microprocessor needs to be reset (power off, then back on).

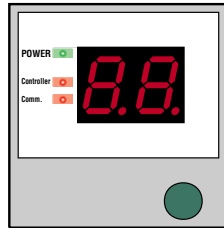

LED lights to the left of the display indicate Power, Controller, and Comm and should appear in this order:

- “Power” shows AC is live to the interface.
- “Comm” lights when the interface is communicating with the Site Interface.
- “Controller” lights after the interface is finished communicating with the SI, and is downloading information into the controller.

GREEN BUTTON.....

The button allows the Controller Interface to receive an address from the SI, and also to enter the diagnostic mode.

TO ADDRESS CONTROLLER INTERFACES.....

1. Install all CI units and communications connections.
2. At the SI, press and hold the “B” button for approximately 5 seconds.
3. The SI display will enter the “racetrack” mode (lights move around perimeter of display). It will remain in this mode until you press “B” again, or until it receives communications from a central computer.
4. With the SI in racetrack mode, visit each CI in order, from the lowest number to the highest number.
5. Press the single green button in the CI once, and the SI will assign it the next available address. Pressing the button causes the SI to see and number the CI.
6. Because the SI is always “01”, the first CI will automatically receive address “02”. The next CI will receive address “03”, etc. When finished with all CIs, return to the SI and press “B” again to exit the racetrack mode and resume normal operations.

DIAGNOSTIC MODE.....

The CI button is also used to start a diagnostic mode which performs two tests.

Press and hold the button for approximately 3 seconds, until “d1” appears.

- **Run Station:** The CI will automatically tell the controller to run station 1 for 1 minute (checks communication between interface and local controller). The green Controller LED will light as it communicates to the controller.
- **Radio check:** Immediately after the Run Station command is sent to the controller, the radio (if one is installed) will transmit a continuous tone for 5 seconds that can be heard on a handheld radio on the same frequency (verifies operation of radio, no effect in non-radio units).

The CI display will occasionally show “P1” or “P2” when connected to the SI. “P1” or “P2” shows that the unit is being “polled” by the SI and that communications are working.

INTERFACE RESET

If the wrong address is set, reset the interface memory by disconnecting the green three-wire power terminal. Press and hold the green button, and plug the power terminal back in. Continue holding the button until the test display “88” disappears, and release. The display will show the version number for a moment, then the “—” display. Repeat the Controller Interface Address procedure to enter the correct address.

ADDITIONAL CONNECTIONS

Turn off or disconnect AC power plug before making any connections inside the CI!

CONNECTIONS TO OTHER INTERFACES

1. To connect to additional Controller Interfaces, route, strip, and connect GCBL cable to the lower section of the CI communications terminals in the same way that the incoming connection was made.
2. Connect the bare silver ground wire in the GCBL to the ground lug.
3. Continue the GCBL run to the next interface (IMMS-CI) in one continuous run, if possible, with no breaks or splices in the communications, and continue the installation.

CONNECTION TO OPTIONAL CLIK SENSORS

1. Connect only Hunter Clik-family sensors to IMMS. Refer to sensor documentation for correct installation of sensor and permissible wire runs.
2. Route sensor wires into the cabinet through low-voltage conduit, and strip wire ends approximately $\frac{3}{16}$ " (4.5 mm).
3. Connect one wire from sensor to "Sensor 1" position on upper terminal strip.
4. Connect other sensor wire to "Sensor Common".
5. Up to 3 sensors may be connected to the CI. Connect one wire from each additional sensor to terminals "Sensor 2" and "Sensor 3", and connect the other wire from each sensor to the "Sensor Common".

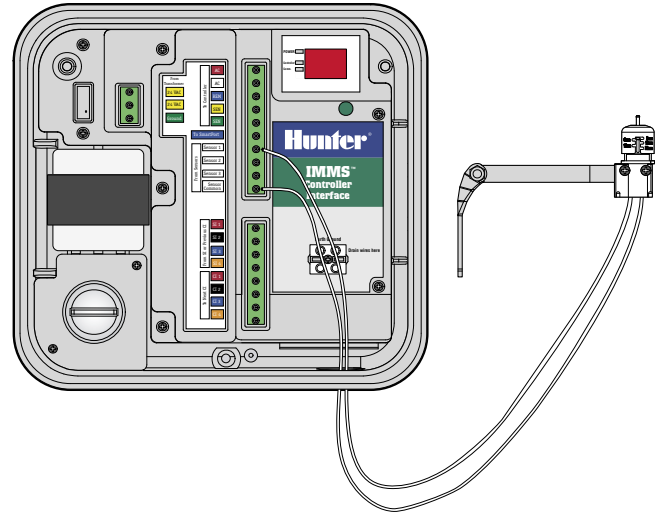

POWERED SENSORS

Hunter's Wireless Rain-Clik™ and the Flow-Clik IMMS require 24VAC power over their yellow wires.

WIRELESS RAIN-CLIK™

1. Route the receiver cable through the low-voltage conduit.
2. Strip and connect the 2 yellow power wires from the sensor receiver to the power terminals in the interface.
3. This will double the yellow wires in each terminal, one each from the interface transformer, and one each from the sensor power.
4. Route and connect the white sensor signal wire to the desired sensor input, and the blue wire to the Sensor Common. The orange wire is not used in an IMMS™ connection.

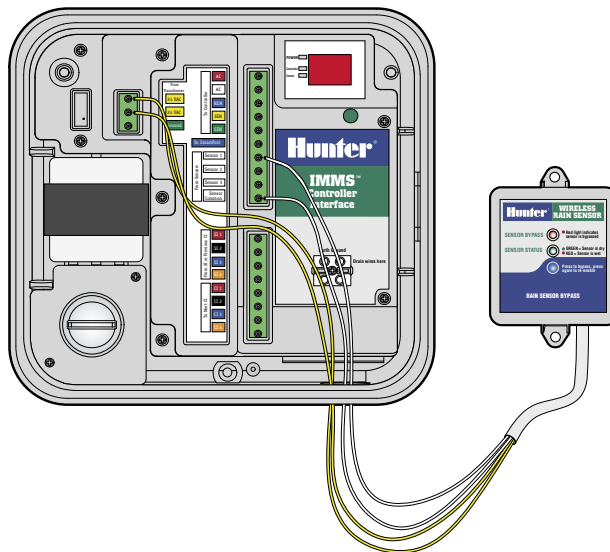

FLOW-CLIK IMMS

1. Route the Flow-Clik™ sensor cable through the low-voltage conduit. Strip and connect the 2 yellow power wires from the sensor receiver to the power terminals in the interface.
2. Connect one of the white wires to the Sensor number, and the other to “Sensor Common”.

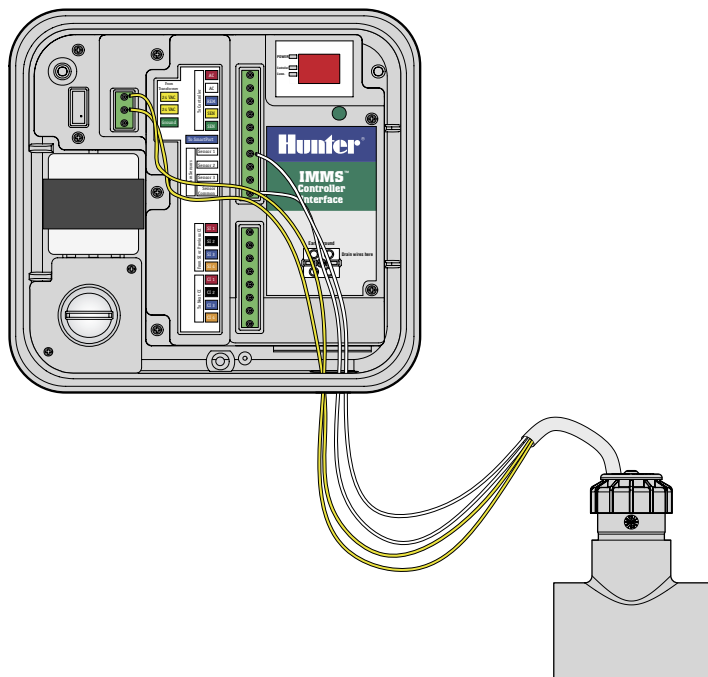

CONNECTION TO OPTIONAL REMOTE RECEIVER (SRR OR ICR)

1. Refer to remote receiver documentation for correct installation of Hunter SmartPort® and permissible wire runs. Connect red and white SmartPort wires to the red and white coded terminals on the upper terminal strip.
2. The red and white wire connections will be doubled, because they are shared with the red and white controller connections.
3. Connect the blue wire from SmartPort to the other blue position labeled "To SmartPort". **Note: The blue SmartPort connection is not shared with any other wires.**

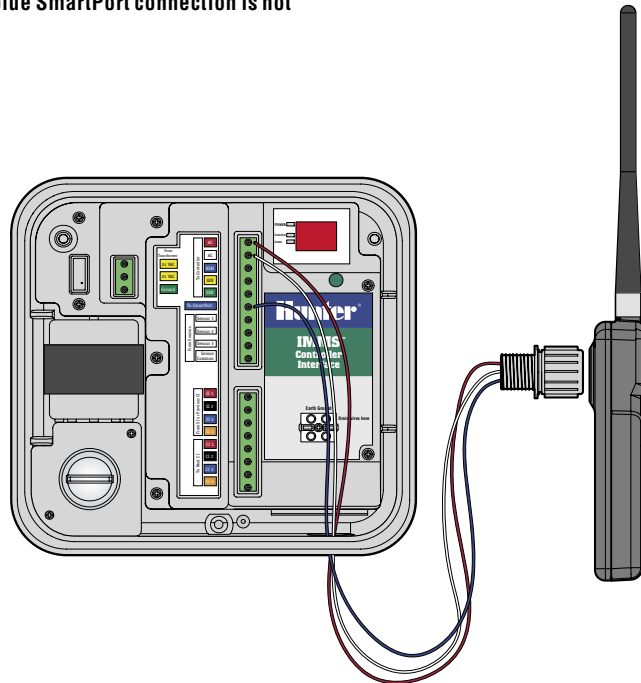

GCBL.....

Two twisted pair (18 AWG/1 mm, orange/blue/black/red), shielded, with ground wire, for direct burial. Used for IMMS interface communications up to 10,000 ft./3 km. Avoid splices in GCBL cable runs.

5 CONDUCTOR SPRINKLER WIRE.....

18 AWG or 1 mm, red/white/blue/yellow/green. Used to connect interface to local controller up 6 ft./2 m.