

ROAM



Residential/Light Commercial Remote Control System

Owner's Manual and
Installation Instructions

For use with Hunter Controllers
with SmartPort® Connection

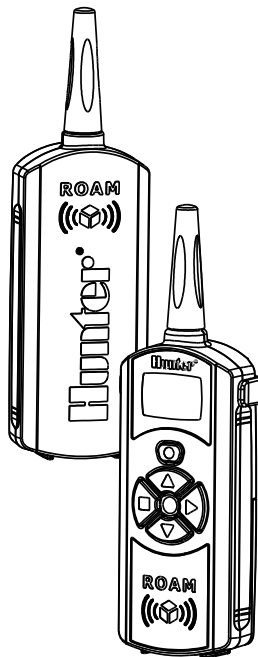

TABLE OF CONTENTS

INTRODUCTION.....	1
ROAM COMPONENTS	2
WIRING HARNESS/SMARTPORT® CONNECTION KIT	5
INSTALLING THE ROAM REMOTE WIRING HARNESS.....	6
WIRING THE SMARTPORT® TO HUNTER CONTROLLERS.....	7
TYPICAL INSTALLATION	8
MAXIMIZING OPERATING RANGE.....	9
EXTENDING WIRING ON SMARTPORT® HARNESS	10
PREPARING THE TRANSMITTER FOR USE.....	11
INSTALLING THE TRANSMITTER BATTERY.....	12
CHANGING THE REMOTE ACTIVATED STATION RUN TIME.....	13
CHANGING THE TRANSMITTER ADDRESS.....	14

TABLE OF CONTENTS (CONTINUED).....





CHANGING THE MAXIMUM STATION NUMBER	15
PREPARING THE RECEIVER FOR USE	16
CHANGING THE RECEIVER ADDRESS	17
ACTIVATING A STATION WITH THE ROAM REMOTE CONTROL SYSTEM	18
A WORD ABOUT RANGE	19
TROUBLESHOOTING GUIDE	20
SPECIFICATIONS	21
NOTES	22
FCC COMPLIANCE NOTICE	24

INTRODUCTION

Finally, there's no need to walk back to the controller to start and stop a manual watering cycle when doing maintenance or repair work on your irrigation system. Finally, winterization can be done quickly and easily with one worker instead of two. Finally no more going back to the garage to start or stop a manual irrigation cycle.

Hunter is pleased to introduce the ROAM Remote Control System for use with Hunter controllers with SmartPort® connection. The ROAM can offer you features other remotes can't, at a price you can afford.

The ROAM transmitter is made of sturdy ABS. It features a large LCD and simple push button operation. Don't let its size fool you—while it's small enough to fit in your shirt pocket, it has an open field range of up to 1000 feet.

The large LCD display and simple four-button control make the ROAM a snap to use. Simply press the  or  keys to display the station or program you want to turn on or off, then press the  or  button—what could be easier? Don't worry about forgetting to turn off the ROAM. After several minutes of inactivity the unit turns itself off to extend battery life. Then, the unit can be turned back on by touching any button. Four AAA alkaline batteries will last an entire season for a contractor, and years for a homeowner.

We believe the ROAM is the simplest remote control available. It is so easy to use that you will need this booklet very little after installation. If you do have a question, keep this in a safe place for easy reference.

Congratulations—your life just got a little easier!

ROAM COMPONENTS.....

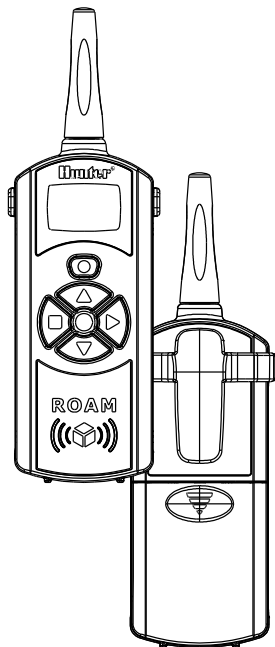

TRANSMITTER

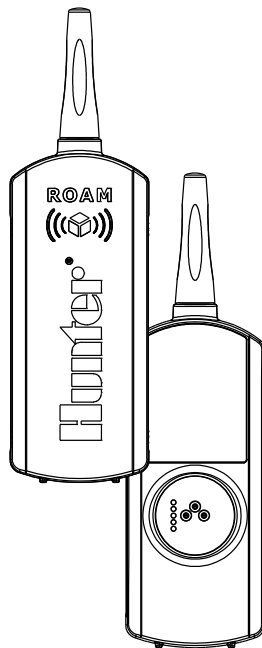

RECEIVER

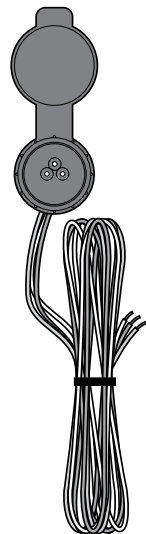





SmartPort®





This section will give you a brief description of the components of the ROAM. Each item will be discussed in further detail later, however this section can be helpful in getting acquainted with the Transmitter, Receiver, and SmartPort®.

TRANSMITTER

A. LCD Display

1.  **Run Time** – Indicates the station run time is being set.
2.  **Transmit** – Indicates that the transmitter is transmitting the programmed data to the receiver.
3.  **Station Number** – Indicates station number (1 to 240).
On – Indicates Transmitter is turning on a particular station.
Off – Indicates Transmitter is turning off a particular station.
PA, PB, PC – Indicates program selected.
4.  **Address** – Indicates that a new address for transmitting between the Transmitter and the Receiver is being set.

B. Control Buttons

5.  – Increases the selected functions.
6.  – Decreases the selected functions.
7.  – Selects the selected functions.
8.  – Cancels the selected functions.
9.  – Scrolls between functions.

C. Other

10. **Battery Cover** – Covers compartment for four AAA alkaline batteries.

ROAM COMPONENTS (CONTINUED).....

RECEIVER

11. **SmartPort® Outlet (Male)** – Outlet on back of Receiver that plugs into the SmartPort harness.
12. **Antenna** – Receives signals from Transmitter from up to 1000'.

SmartPort®

13. **SmartPort Outlet (Female)** – Outlet on front of SmartPort® that plugs into the ROAM Receiver or other Hunter product.
14. **Rubber Cover** – Protects SmartPort from dirt and weather.
15. **Control Wires** – Red, white, and blue wires that connect to the terminal strip area of the controller.

WIRING HARNESS/SMARTPORT® CONNECTION KIT

To utilize the ROAM Remote Control System, your controller must be equipped with the SmartPort wiring/harness connection kit. This wiring harness provides the connection port where the ROAM receiver is attached.

The SmartPort wiring harness is included with the purchase of the ROAM. Additional SmartPorts may be purchased separately to allow you to utilize the transmitter and receiver with additional Hunter controllers.

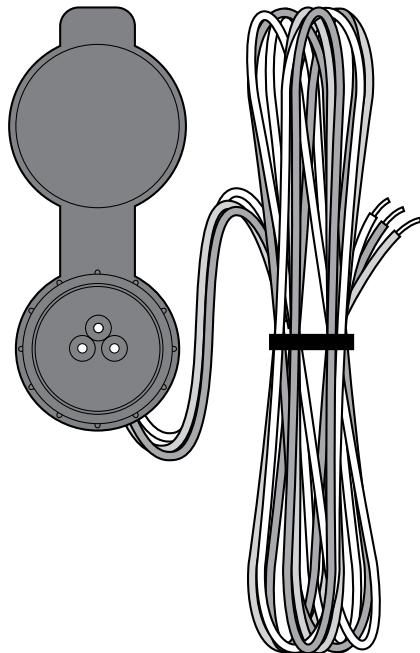

INSTALLING THE ROAM REMOTE WIRING HARNESS.....



NOTE: Any extension of the wires provided with the standard wiring harness may result in an error message on the controller display and possible malfunction of the remote due to radio interference. In some situations, lengthening of the standard harness may work fine, in others it may not work at all (it is site specific). In either case, it is recommended that installations where the SmartPort® outlet will be located more than 5 feet from the controller that the installation be done using the shielded cable wiring harness (ROAM-SCWH) to minimize the possible effects of electrical noise.

1. Install a ½" female threaded "Tee" in the field wiring conduit approximately 12" from the controller.
2. Feed the red, white, and blue wires of the SmartPort through the base of the "Tee" and into the controller wiring compartment as shown in Figure 1.



NOTE: While the SmartPort has a protective cover to allow for outdoor installation, the ROAM Receiver should only be used on a temporary basis, as the Receiver is not designated for permanent outdoor mounting.

3. Screw the SmartPort housing into the "Tee" (or other fitting) as shown in Figure 1.
4. Route wiring harness into controller housing. Attach the red wire to the first **AC** screw slot. Attach the white wire to the other **AC** screw slot, and attach the blue wire to the **R** (or **REM** on some controllers) as shown in Figure 2.

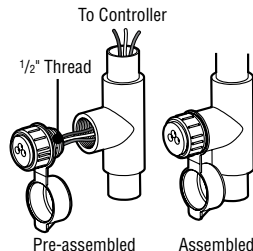
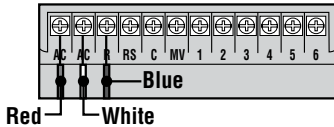

Figure 1

WIRING THE SMARTPORT® TO HUNTER CONTROLLERS

SRC Controller SmartPort Installation

Access the terminal strip area and attach the red wire to the left **AC** screw slot, attach the white wire to the next **AC** screw slot and attach the blue wire to the screw slot marked “**R**”.



Pro-C Controller SmartPort Installation

Access the terminal strip area on the main module and attach the red wire to the bottom most **AC** screw slot, attach the white wire to the upper **AC** screw slot and attach the blue wire to the screw slot marked “**REM**”.

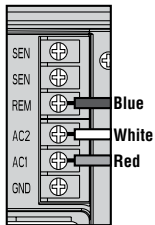

ICC Controller SmartPort Installation

Access the terminal strip area on the power module and attach the red wire to the bottom most **AC** screw slot, attach the white wire to the upper **AC** screw slot and attach the blue wire to the screw slot marked “**REM**”.

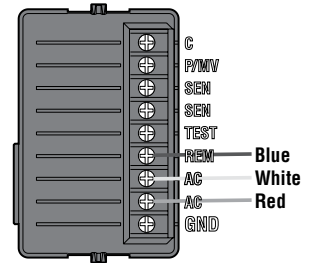

TYPICAL INSTALLATION.....

Receiver Mounted Indoors

This installation is ideal for situations when the ROAM system will be left permanently connected to the controller in an indoor area.

Connection of Receiver on a Temporary Basis from Outside of a Garage or Building

This installation is ideal for situations where a contractor desires the ability to access and operate a controller from outside of a locked building or garage. However, the ROAM receiver must be removed from the SmartPort® and the weather resistant cap placed back on the outlet after each use.

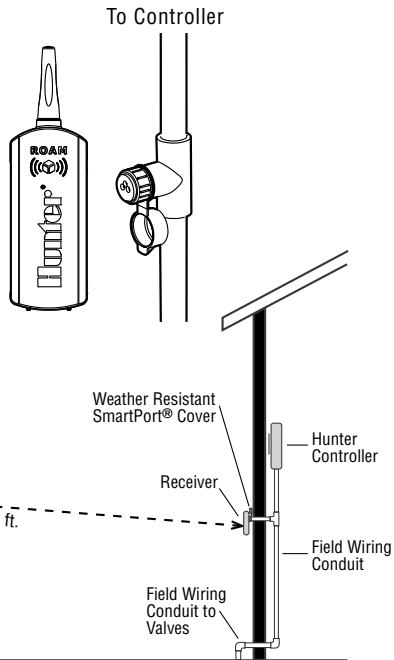

MAXIMIZING OPERATING RANGE

There are many factors which influence operating range. Listed below are a few things you can do to assure that you get maximum range possible.

1. Do not install SmartPort® near large sources of metal such as power meters, water pipes, and aluminum siding.
2. Do not install SmartPort in a basement or underground location. The higher the location the better chance of strong reception.
3. For maximum range in all directions, the receiver should be pointed straight up (vertically). If receiver is mounted with its antenna oriented horizontally, reception will be very good if transmitter is on either side of the antenna, but very poor if it is facing either end of the receiver antenna.
4. When operating transmitter, hold the transmitter as vertical as possible and face in the direction of the receiver, especially if it is several hundred feet away.



NOTE: Remote is designed for residential and small commercial sites. Large projects such as cemeteries and golf courses will require a long-range remote.

EXTENDING WIRING ON SMARTPORT® HARNESS

Use shielded cable to connect the SmartPort to the controller if installing the connector more than 2 meters of wiring length from the controller. The use of shielded cable will eliminate the potential for radio interference by preventing the wire as acting as an antenna. At no time should the SmartPort be installed more than 15 meters away from the controller.

For easiest installation, order a Hunter **SRS-SCWH** SmartPort wiring harness with a full 7.6 meters of shielded cable.

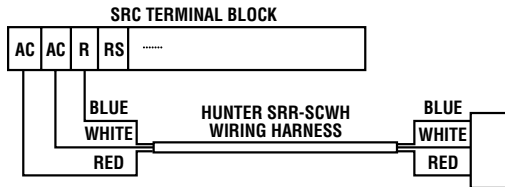

ICC TERMINAL BLOCK

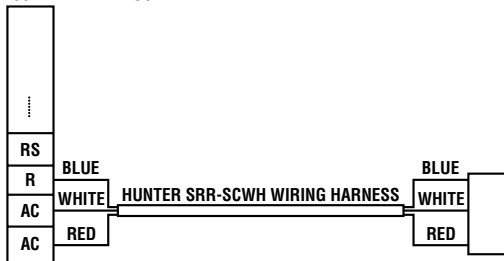

PRO-C TERMINAL BLOCK

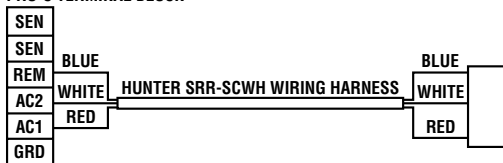

PREPARING THE TRANSMITTER FOR USE

Your ROAM System is designed to work right out of the box. This means that other than installing the batteries, you may choose to skip this entire section. However, we recommend you read it because with a few simple steps you can customize your ROAM to add functionality and security to your system.

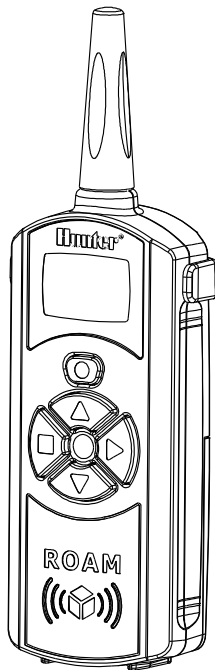

INSTALLING THE TRANSMITTER BATTERY



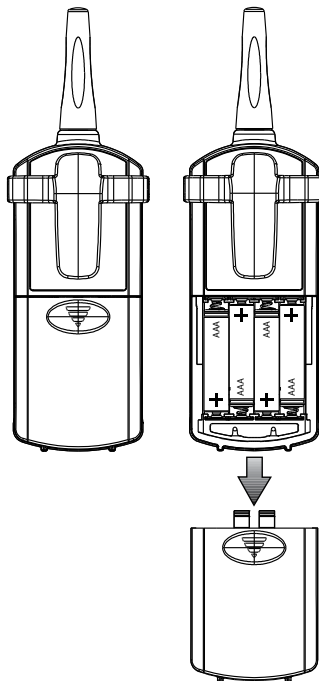

Your ROAM Transmitter requires four AAA alkaline batteries. To install the batteries, slide open the battery door on the back of the transmitter. When changing the batteries, make sure that they are oriented properly in the battery holder. Slide the battery door shut.



CHANGING THE REMOTE ACTIVATED STATION RUN TIME.....

You have the ability to adjust the amount of time that a station will run once it has been turned on by your ROAM System. This does not affect the run time programmed into your controller. There are 10 preset run times from 1 minute to 90 minutes.

To change the Remote Activated Station Run Time follow the steps below:

1. If the unit is off (no display), power the transmitter up by pressing or any of the buttons for at least 1 second and then releasing the button. The transmitter will first display the active station.
2. Press the Mode button  once and the Run Time icon  displayed (default is 2 minutes). If more than 10 seconds go by without a button being pressed, the Transmitter will revert back to displaying the active station.
3. Use the  and  buttons to change the Run Time to any of the 10 settings ranging from 1 to 90 minutes. Then do not touch any of the buttons for 10 seconds and the display will return back to the active station.

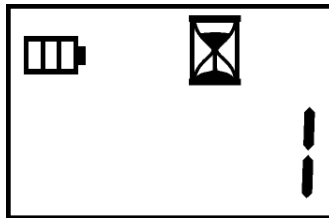



CHANGING THE TRANSMITTER ADDRESS

Both the ROAM Transmitter and Receiver have an “address” that they use when communicating. If the addresses do not match, the receiver will ignore the transmission.

Your ROAM comes from the factory with both the Transmitter and the Receiver address set to 1. You may change the address to any value from 0 through 127 for added security. Note that if you change the Transmitter address, the Receiver must “learn” the new address as described in “Preparing the Receiver for Use” section.



To change the Transmitter address follow the steps below:

1. If the unit is off (no display), power the Transmitter up by pressing any of the buttons for at least 1 second then releasing the button. The Transmitter will display the active station.

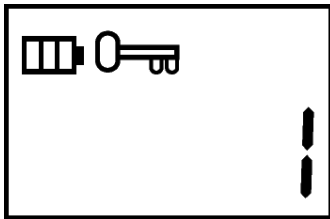
2. Press the Mode button until the Address Key icon is displayed.
3. Use the  and  buttons to change the address to any value between 0 and 127. Then do not touch any of the buttons for 10 seconds and the display will return back to the active station.





CHANGING THE MAXIMUM STATION NUMBER

Your ROAM Transmitter comes from the factory with the maximum station number set to 15. This means that when you use the  and  buttons to change the station, you may change it to any number between 1 and 240. However, if you only have a 6-station controller, you will never need to access stations 7 through 9. Likewise, perhaps you will own a Hunter controller like the ICC which can have more than 9 stations. In this case you would want to access the stations above 9.

Caution: If MAX station is set to 240, ROAM will only work with the ACC controller. If you are using an SRC, Pro-C, or ICC controller, make sure your station count is set to 1 - 48.

The ROAM Transmitter allows you to set the maximum station number as follows:

1. If the unit is off (no display), power the Transmitter up by pressing any of the buttons for at least 1 second then releasing the button. The Transmitter will display the active station.
2. Press the Mode button until the Station Number icon is  displayed.
3. Use the  and  buttons to change the maximum station number from 1 to 240. Then, do not press any buttons for 10 seconds and the display will return to the active station number
4. You may now change the active setting to any station in the new station range.

PREPARING THE RECEIVER FOR USE.....





As stated earlier, your ROAM System is designed to work right out of the box. If you have decided to change your Transmitter address as described in the previous section, you must allow the Receiver to “learn” this new address. Once learned, the only way to remove the address from Receiver memory is to learn a different address. This can be done by following the simple steps outlined below.

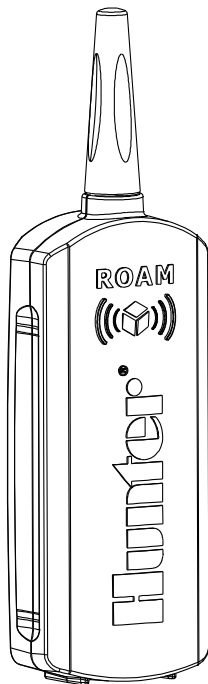

NOTE: The ROAM remote receiver should not be permanently installed in an outdoor or unsheltered location.









CHANGING THE RECEIVER ADDRESS.....

1. Before setting the receiver address, make sure that the transmitter address is set to the address you would like to use.
2. Plug the receiver into a SmartPort® connected to a powered controller. When this is done, the receiver will beep 4 times.
3. Once the receiver beeps 4 times, you have approximately 10 seconds to send the new address to the receiver. Press either the  or  button on your transmitter to connect.
4. The receiver will beep 4 additional times indicating that it has learned the new transmitter address and will respond only to that address from this point on. If 10 seconds expire before the  or  button is pressed, the receiver will beep once and retain its original address.

ACTIVATING A STATION WITH THE ROAM REMOTE CONTROL SYSTEM.....

The ROAM System will allow you to remotely turn on and off any station on your Hunter controller with the press of a button. Once on, the station will run for the run time you have designated in the remote. To remotely activate a station or program follow the steps below:

1. Plug the receiver into a SmartPort® that is connected to a powered controller. The receiver will beep 4 times followed by a 10-second pause and a single beep.
2. If your transmitter is not on (no display), press any button for at least one second and release. The Transmitter will display the active station.
3. Use the  and  buttons to display the station or program you would like to start.
4. Press the  button to start the station or program. The Transmitter will display the Transmit icon . If you are near the receiver, you will hear it beep 2 times. This indicates that the Receiver has received the command.

5. Press the  button to turn off any station that is on. The display will show the Transmit icon  and receiver will beep again twice. The ROAM System is designed to turn on one station at a time (unless you activate a program). Therefore, turning a station on while another station is operating will cause the operating station to turn off.



NOTE: The ROAM remote can activate any station on the controller whether the controller dial is in the “SYSTEM OFF”, “RUN” or “RUN/BYPASS SENSOR” modes. If a sensor device has been wired to the controller, the ROAM remote will NOT override the sensor for manual operation.

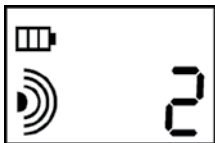

A WORD ABOUT RANGE.....

There are many claims being made about the range of various remote control systems, whether they be for auto alarms, garage doors, or irrigation systems for that matter. The published range for the ROAM System is up to 1000 feet. Most users will achieve this range or more, but a few may not. It is the attempt of this section to educate the user about those factors that influence operating range. We believe that we have achieved the maximum performance available on this frequency. Here's why...

The range of any remote control system is dependent on many factors. These include the terrain at a particular site, obstructions such as buildings and walls, the strength of the various interfering signals, the sensitivity of the Receiver, the ability of the Receiver to reject "unwanted" signals, and the strength of the Transmitter. Since it is impossible to control the obstructions, terrain at a site, and the strength of interfering signals, it is impossible to guarantee an operating range under all conditions. However, we have done everything under our control to maximize the operating range of this system.

The ROAM Transmitter has been designed to transmit the maximum power allowed by the FCC. Furthermore, it has special circuitry to assure that this maximum output power is maintained until just before the battery goes dead. Other transmitters emit less and less power as the battery wears down. And our special SmartPort® wiring harness is designed to keep interfering signals at a minimum, especially with the addition of Hunter shielded cable. The Receiver employs a reception method far superior to that used in a typical garage door opener or car alarm.

The ROAM has been designed to give you simple, reliable operation for many years.

TROUBLESHOOTING GUIDE

PROBLEM	CAUSES	SOLUTIONS
Transmitter display is blank.	Transmitter is off. Batteries are dead.	Press any button for 1 second.
Can't access all the desired stations on the Transmitter.	Maximum station number is set wrong.	See "Changing the Maximum Station."
Receiver doesn't beep 4 times after plugging it in.	SmartPort [®] is not connected properly. Controller has no power.	Recheck SmartPort wiring. Check controller power.
Receiver won't respond to Transmitter.	Receiver and Transmitter address don't match	Relearn address at receiver.
Transmitter display stays on.	Transmitter will turn off automatically.	Wait approximately 5 minutes without pressing any buttons. Transmitter will "fall asleep."
"ERR" message in controller display when controller is in the run position.	SmartPort wiring leads have been extended and are receiving radio interference.	Replace lengthened wire with shielded cable to prohibit radio interference. Use Hunter ROAM-SCWH. See "Extending Wiring on SmartPort Harness."
Receiver does not receive signal from remote held at close range.	Mismatch of addresses in transmitter and receiver.	Reset address of receiver.
Remote has short range (i.e. less than 100 feet).	Check for interference causes.	See "Maximizing Operating Range."

SPECIFICATIONS

Operating Specifications

- Address range: 0 - 127
- Maximum stations supported: 240
- Run Time: 10 settings from 1-90 minutes
- Range: up to 1,000 feet*

Electrical Specifications

- Power Source Transmitter:
(4) AAA Alkaline Batteries
- Power Source Receiver:
24VAC, 0.010 Amps
- Receiver type: Superheterodyne
- System Operating frequency: 433.925 MHZ

Default Settings

- Address = 1
- Number of stations = 15
(may be varied from 1-240)
- Run Time: 2 minutes

Dimensions

Transmitter:

- Height: 7"
- Width: 2¼"
- Depth: 1¼"

Receiver:

- Height: 7"
- Width: 2¼"
- Depth: 1"

*See "A Word About Range" for more information.

FCC NOTICE.....

Transmitter FCC ID:M3URMT

This device complies with FCC rules Part 15. Operation is subject to the following two conditions:

1. This device may not cause harmful interference and
2. This device must accept any interference received, including interference that may cause undesired operation.

This equipment has been tested and found to comply with the limits for class B digital devices, pursuant to part 15 of the FCC Rules. These limits are designed to provide reasonable protection against harmful interference in a residential installation. This equipment generates, uses, and can radiate radio frequency energy and if not installed and used in accordance with the instructions, may cause harmful interference to radio communications. However, there is no guarantee that interference will not occur in a particular installation. If this equipment does cause harmful interference to radio or television reception, which can be determined by turning the equipment on and off, the user is encouraged to try to correct the interference by one or more of the following measures:

- Reorient or relocate the receiving antenna
- Increase the separation between the equipment and the receiver
- Connect the equipment to an outlet on a circuit different from that to which the receiver is connected
- Consult the dealer or an experienced radio/TV technician for help

The user is cautioned that changes and modifications made to the equipment without the approval of the manufacturer could void the user's authority to operate this equipment.

FCC DECLARATION OF CONFORMITY

TRADE NAME	Remote Control Device
MODEL NUMBER	ROAM-R
COMPLIANCE TEST REPORT NUMBER	B80912D1
COMPLIANCE TEST REPORT DATE	Sept 12th, 2008
RESPONSIBLE PARTY	Hunter Industries Incorporated
ADDRESS	1940 Diamond St, San Marcos CA 92078
TELEPHONE	760-744-5240

This equipment has been tested and found to comply with the limits for class B digital devices, pursuant to part 15 of the FCC Rules. These limits are designed to provide reasonable protection against harmful interference in a residential installation. This equipment generates, uses, and can radiate radio frequency energy and if not installed and used in accordance with the instructions, may cause harmful interference to radio communications. However, there is no guarantee that interference will not occur in a particular installation.

If this equipment does cause harmful interference to radio or television reception, please refer to you user's manual for instructions on correcting the problem.

I the undersigned, hereby declare that the equipment specified above conforms to the above requirements.

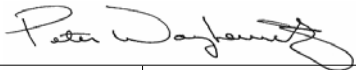
Signature: 	
Place: San Marcos, CA	Full Name: Peter Woytowicz
Date: September 25, 2008	Position: Engineering Manager

INDUSTRY OF CANADA NOTICE

Transmitter - IC:2772A-RMT

Receiver - IC:2772A-RMR

Operation is subject to the following two conditions:

This device may not cause harmful interference and

This device must accept any interference received, including interference that may cause undesired operation.

CE & AUSTRALIA NOTICE

Hunter Industries hereby declares that this remote control device is in compliance with the essential requirements and other relevant provisions of Directive 1999/5/CE.

Declaration of Conformity: We, Hunter Industries Incorporated, 1940 Diamond Street, San Marcos, CA 92078, declare under our own responsibility that the ROAM remote control product, model numbers ROAM-TR and ROAM-R, to which this declaration refers, conforms with the relevant standards:

Emissions: ETSI EN 300 220-1 V2.1.1
ETS I EN 300 220-2 V2.1.1
ETS I EN 301 489-1 (per EN55022)
EN 61000-3-2
EN61000-3-3

Immunity: ETSI EN 301 489-1 V1.4.1
(per IEC61000-4-2 through IEC61000-4-6,
and IEC61000-4-11)

Signature: 	
Place: San Marcos, CA	Full Name: Peter Woytowicz
Date: September 25, 2008	Position: Engineering Manager

Hunter Industries Incorporated • The Irrigation Innovators

1940 Diamond Street • San Marcos, California 92078

www.HunterIndustries.com

© 2008 Hunter Industries Incorporated

LIT-477 12/08