

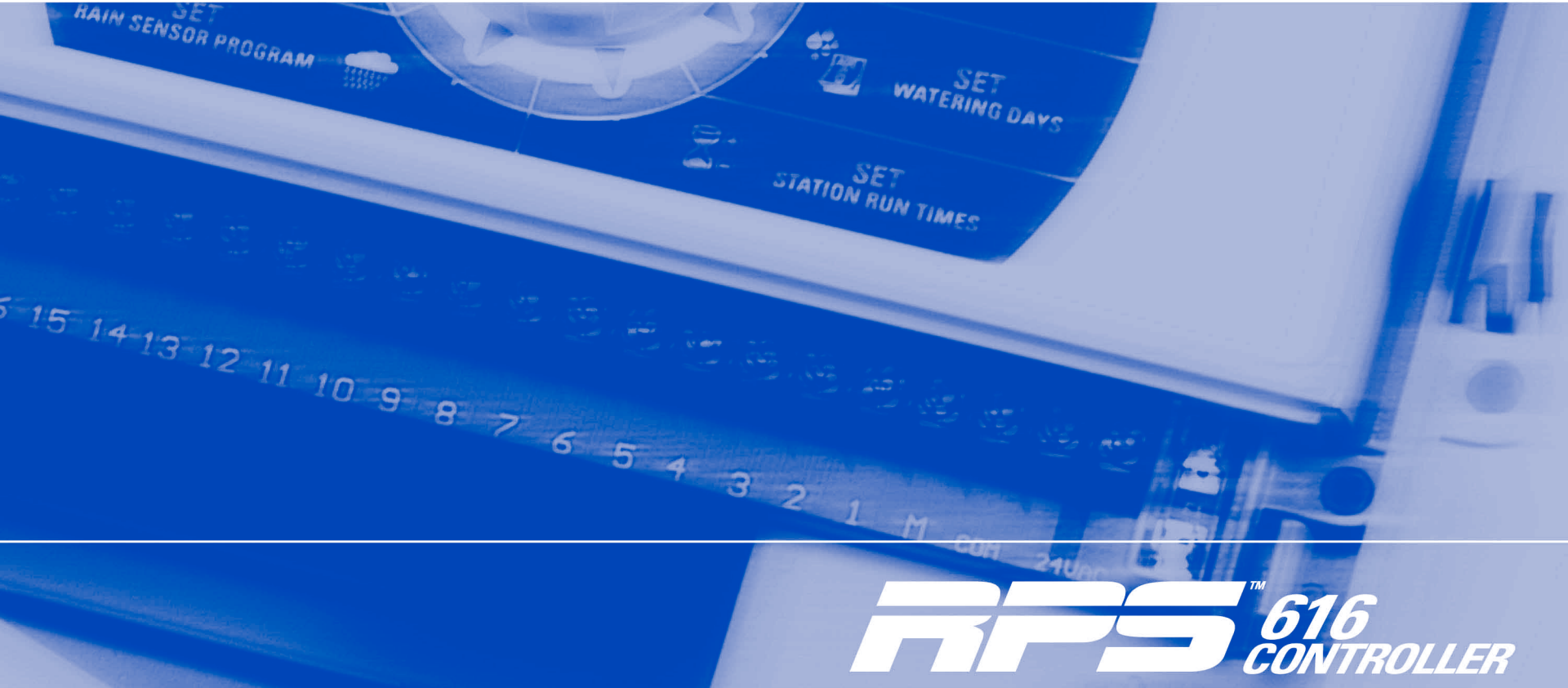

IRRIGATION SOLUTIONS
WORLDWIDE™

RPS616 INSTALLATION, PROGRAMMING AND OPERATION MANUAL



RPS™ **616**
CONTROLLER

INTRODUCTION

This unit is available in six, nine, twelve and sixteen station configurations. Designed for residential and light commercial applications, this controller has four separate schedules with up to sixteen start times a day to ensure efficient watering of a wide variety of landscapes. Different areas may require individual watering schedules and often use different types of sprinklers.

EXAMPLES: Turf areas generally use gear drive sprinklers and require less frequent but heavier watering. However, flower beds use pop up sprays and require more frequent watering. Stations (valves) which water similar landscape areas are often grouped together and put into the same program. Stations (valves) will water in sequential order from the lowest number and on the days selected. Maximum watering duration for a station (valve) is 12 hours and 59 minutes.

This controller has a 7 day watering schedule with individual day selection per program or a 365 calendar for Odd/Even day watering or selectable interval watering schedules from everyday to every 15th day.

FEATURES

A feature of this controller is the water saver feature which allows quick adjustment of the station watering times by percentages as the seasons change.

Another key feature of this controller is the Rain Sensor Ready technology (RSR) which allows individual stations to be controlled by a rain switch. The switch will automatically stop the watering programs for selected stations during wet periods.

CONTENTS

FEATURES	02
GLOSSARY	03
PROGRAMMING INSTRUCTIONS	03
INTRODUCTION	04
PROGRAMMING EXAMPLE	04
OTHER FUNCTIONS	05
GENERAL TIPS FOR PROGRAMMING	05
PROGRAMMING	
SET CURRENT TIME & CORRECT DAY	05
SET CALENDAR (OPTIONAL)	05
STEP 1. SET START TIMES	06
STEP 2. SET WATERING DAYS	06
INTERVAL DAY SELECTION	06
INDIVIDUAL DAY SELECTION	06
ODD / EVEN DAY SELECTION	07
STEP 3. SET STATION RUN TIMES	07
MANUAL OPERATIONS	
RUN A SINGLE STATION	08
SYSTEM TEST	08
RUN A PROGRAM	08
OTHER FEATURES	
STOP	08
STACKING START TIMES	08
AUTOMATIC BACKUP PROGRAM	08
RAIN SENSOR READY FEATURE	09
RAIN OFF MODE	09
WATER BUDGETING & SEASONAL ADJUSTMENTS	09
FAULT FINDING GUIDE	10
INSTALLATION INSTRUCTIONS	
MOUNTING THE CONTROLLER	10
ELECTRICAL HOOK-UP	10
FIELD WIRING CONNECTIONS	11
TERMINAL BLOCK LAYOUT	11
POWER SUPPLY CONNECTIONS	11
PUMP START RELAY & MASTER VALVE CONNECTIONS	12
CONNECTION OF VALVES + RAIN SWITCH	12
RAIN BYPASS SWITCH	12
ELECTRICAL CHARACTERISTICS	13
SERVICING THE CONTROLLER	13
SPARE WATERING PLANNERS	14
WARRANTY INFORMATION	15

GLOSSARY



LARGE LCD DISPLAY
Easy to read

PROGRAMMING BUTTONS
Used for Adjusting
programmed information

SELECTION DIAL
Used for Operations
& Programming.

TERMINAL COVER
Remove to access station terminals
& to change 9V battery



TERMINATION COVER

Electrical contractor access ONLY.
"WARNING" HIGH VOLTAGE

PROGRAMMING INSTRUCTIONS

INTRODUCTION

This controller has been designed with four separate programs to allow different landscape areas to have their own individual watering schedules.

A program is basically a method of grouping stations (valves) with similar watering requirements to water on the same days. These stations will water in sequential order and on the days selected.

The important elements of programming your controller are:

- Group the stations (valves) which are watering similar landscape areas together. Examples: Turf, flower beds, gardens. These different groups may require individual watering schedules.
- Plan your watering schedule completing the planner supplied at the back of this book.
- Set the current time and correct day of the week.

SET AUTOMATIC PROGRAM

- Set the automatic program for each group of stations (valves) by completing the following three steps:

1. Set Starts

This sets the time when the watering schedule is to commence. Note: For each start time, all the stations (valves) selected for the program will come on in sequential order. If two start times are set, the stations (valves) will come on twice.

2. Set Watering Days

These are selected days when the automatic system will be active.

3. Set Station Run Times

This sets the watering duration required for each station (valve).

PROGRAMMING EXAMPLE (right)

A typical example of a 12 station system is outlined to the right as a guide to assist you when planning your watering schedule. In this example, the lawn areas are using gear driven sprinklers. The garden is using drip and the flower beds are being watered using pop-up sprays.

STATION NUMBER		5	GARDEN BED	11	BACK LAWN
		6	GARDEN BED	12	GARDEN BED
1	FRONT LAWN	7	BACK LAWN	13	
2	FRONT LAWN	8	SIDE LAWN	14	
3	FRONT LAWN	9	BACK LAWN	15	
4	GARDEN	10	BACK LAWN	16	

PROGRAM	START TIME		WATERING INTERVALS		STATION	STATION
	START TIME	WATERING INTERVALS	RUN TIME (MINUTES)	STATION	RUN TIME (MINUTES)	
1	START TIME 1: 4:00 a.m.	MONDAY	1	20	9	20
	2ND START TIME:		2	20	10	20
	3RD START TIME:		3	20	11	20
	4TH START TIME:		4		12	
	WEDNESDAY	5		13		
		6		14		
		7	20	15		
		8		16		
2	START TIME 1: 6:00 a.m.	EVERYDAY	1		9	
	2ND START TIME:		2		10	
	3RD START TIME:		3		11	
	4TH START TIME:		4	30	12	
	5			13		
	6			14		
	7			15		
	8			16		
3	START TIME 1: 5:00 a.m.	EVERY 2ND DAY	1		9	
	2ND START TIME:		2		10	
	3RD START TIME:		3		11	
	4TH START TIME:		4		12	10
	5		10	13		
	6		10	14		
	7			15		
	8			16		
4	START TIME 1: 7:00 a.m.	EVERYDAY	1		9	
	2ND START TIME:		2		10	
	3RD START TIME:		3		11	
	4TH START TIME:		4		12	
	5			13		
	6			14		
	7			15		
	8		20	16		

PROGRAMMING INSTRUCTIONS

OTHER FUNCTIONS

This controller can also manually run a selected program once, or an individual station can be set to run once from 1 minute up to 12 hours and 59 minutes. During wet conditions the automatic schedules can be suspended to prevent watering while it is raining.

This feature can be selected for individual stations by using a rain switch or by using the dial if no switch is connected. A test for checking the stations (valves) and sprinklers is also provided.



TURN DIAL TO
REQUIRED SETTING

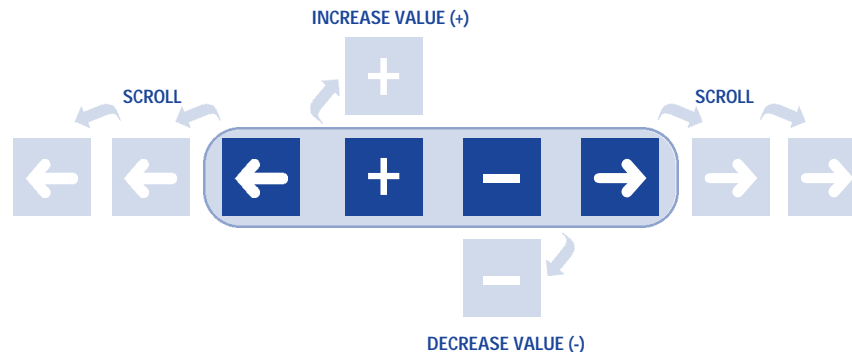

GENERAL TIPS FOR EASY PROGRAMMING

Tips to help eliminate programming confusion.

1. Complete the spare watering planner.
 2. When setting, one push of the button will increment one unit.
 3. Holding one button down will fast scroll through units.
 4. During programming, only flashing units are able to be set.
- Adjust stations by using **+** or **-** buttons.
5. Pressing **→** will scroll forward through the settings in an orderly sequence.
 6. Pressing **←** will scroll back to previous settings and settings can be changed.

PROGRAMMING

SET CURRENT TIME & CORRECT DAY

Turn the dial to **Set Clock/Calendar** position. The hour will be flashing.

Use **+** or **-** to adjust.
Note: AM / PM must be set correctly.

Press **→** button and the “minutes” will flash.

Use **+** or **-** to adjust.

Press **→** and the “day of the week” will flash.

Use **+** or **-** to set correct day.

SET CALENDAR (OPTIONAL)

NOTE: The calendar only needs to be set when selecting Odd/Even day watering in areas where water restrictions may require this feature.

Press **←** button until the year, month and day are shown. the “year” will be flashing.

Use **+** or **-** to adjust, if required.

Press **←** button and the “month” will flash.

Use **+** or **-** to adjust.

Press **←** and the “day” will flash.

Use **+** or **-** to adjust.

Tip: To return to the clock, press **←** , Then **→** or turn dial to another position.

PROGRAMMING

Before proceeding, ensure the spare watering planner has been completed. From your planner, you should be aware which stations (valves) are allocated to each program. Set one program at a time to ensure that the schedules are completed correctly.

Example: SET PROGRAM 1

Step 1. Set Start Times

NOTE: All stations will come on in sequential order for each start time.

Turn the dial to **Set Start Times** and ensure that "Prog 1" is flashing.

The display will show:

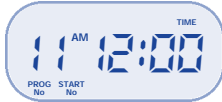

Press **→** and "Start 1" will flash.

Press **→** and the "hour" will flash.

Use **+** or **-** to adjust.

Note: Ensure AM / PM position is correct.

Press **→** and the "minutes" will flash.

Use **+** or **-** to adjust, if required.

Each program has up to four start times and should you require a second start time,

Press **→** twice and "Start1" will flash.

Advance to start 2 by pressing **+**.

The display will show:



Press **→** and proceed as per setting **Start 1**.

TIP: To turn an active start time off, turn the dial to the **Set Start times** position,

Select the program number by using **+** and then press **→**,

Select the start number required using the **+** button.

Press **→** until the "hour" is flashing.

Use **+** or **-** until "OFF" is shown.

TIP: "OFF" position is between 12 and 1.

Step 2. Set Watering Days

This unit has interval watering from everyday to every 15th day, individual day selection or a 365 day calendar with odd/even day selection in areas where water restrictions require this feature.

Interval Day Selection

Turn the dial to **Set Watering Days**.

The display will show:



"Interval 1" will be flashing. This means that watering will occur every day.

To change the interval day, press **+** button.

Examples: Interval 2 means watering will take place every second day, 3 means watering will take place every third day etc.

Interval watering can be set from everyday to every 15th day. The Run Day refers to the number of days before the next watering schedule will occur.

Individual Day Selection

Press the **→** button.

This is the **selectable** day option.

The display will show:



This refers to Mon being Day 1

To turn Monday off, press **-** button.

PROGRAMMING

To leave Monday active, leave as is and advance to Tuesday (day 2)

by **pressing the**  button.

Again **press the**  button to set the day off if required, followed by  to advance.

Continue until all seven days have been set "on"  or "off" .

Odd / Even Day Selection (Optional)

In some regions users are only allowed to water their landscapes on ODD dates if their house number is ODD, or on EVEN dates when their number is EVEN.

This controller allows this to be done simply by setting the relevant selection of ODD or EVEN and setting the current date into the controller. The controller will account for leap years.

If you require the ODD / EVEN day option,

simply **press the**  button until "Odd" is shown.

Press the  button and "Even" will be shown.

This feature may be required in areas where water restrictions are enforced.

NOTE: Remember to set the 365 day calendar when setting the clock, or this feature will be out of sequence. (Refer Page 5 "Set Calendar")

Step 3. Set Station Run Times

This is the length of time that each station (valve) is scheduled to water on a particular program. Maximum watering time is 12 hours 59 minutes for each station. A station can be assigned to 1, 2, 3 or 4 programs if required.

Turn the dial to the Set Station Run Times position.

The display will show:



This means station 1 has a default run time of 10 minutes in program 1. Station 1 will be flashing.

To adjust the **Run time** in minutes **press** , and use  or .

To set the run time in hours, **press**  and "0" will appear and flash.

To adjust use  or .

If not required **press**  and advance to station 2 by **pressing the**  button.

Continue until all the stations in Program 1 have been set with a run time or if a station(s) is not required to be active in this particular program, ensure that the Run time is set to "OFF".

NOTE: To set a station to "OFF" Use  when the "RUN TIME" is flashing, or **press**  &  simultaneously.

This completes the setting up procedure for automatic watering of Program 1.

Select from 4 programs for different watering schedules.

Should you need the second program to have an automatic schedule, **turn the dial to "Set Start times"** and "Prog 1" will flash.

Press  and change to program 2 position and follow the same 3 steps for automatic watering.

1. Set Starts

2. Set Watering Days

3. Set Station Run Times

TIP: Remember to return the dial to the "Auto Run" position at the completion of the setting up of the automatic schedules. This will ensure that the automatic cycles will take place.

MANUAL OPERATIONS

RUN A SINGLE STATION

The maximum Run time for a station is 12 hours 59 minutes. To manually run a single station once, **turn** the dial to **System Test or Run Single Station** position.

The display will show:



To adjust the Run Time, use the **+** button and to advance to the next station

press the **→** button.

SYSTEM TEST

This feature can be used to test that your valves and sprinklers are working correctly. **Turn** the dial to **System Test or Run Single Station** position.

The display will show:



The controller will run through all stations for 2 minutes in sequential order while you go and check your sprinklers.

NOTE: The system test is preset at 2 minutes per station and can NOT be adjusted.

RUN A PROGRAM

To manually run a complete program once for the run times as set in the automatic schedule. **Turn** the dial to the **Run Program** position.

“Prog 1” will be shown in the display.

To run program 1, leave or advance to program 2 by pressing **→**.

NOTE: If a rain switch is connected and the display shows “SEN WET”, the stations set to rain sensor “ON” will not activate. However individual stations can be watered by using the **Run Single Station** facility.

OTHER FEATURES

STOP

To stop an automatic or manual watering schedule, turn the dial to the **Off** position.

TIP: for automatic watering remember to turn the dial back to the **Auto Run** position, as the **Off** position will stop any watering cycles from occurring.

STACKING START TIMES

Should you accidentally set the same watering start time on more than one program, the Controller will stack them in sequential order from the lowest number. All programmed start times will be watered.

AUTOMATIC BACKUP PROGRAM

When the battery is not connected or is dead there is a backup default program in program 1 watering every day at 12:00am for 10 minutes per station.

A standard 9 volt alkaline battery should be connected to the battery snap to maintain the clock accuracy and hold the automatic programs during a power outage.

TIP: The display has a warning indicator to let you know when the battery is low or not connected. The word **BAT** appears just under the **AM / PM** indicator when the clock is shown.

OTHER FEATURES

RAIN SENSOR READY FEATURE

IMPORTANT: The bypass switch at the terminal should be moved to the "ON" position before fitting a rain switch.

This feature is only used when a rain switch has been connected. When using a standard rain switch, connect the cables from the switch to the terminal blocks marked "COM & "RAIN". Turn the dial to **Set Rain Sensor Program** to enable individual stations to be set rain sensor "ON or "OFF".

The display will show:

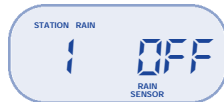

NOTE: All stations are set "OFF" at first power up.

The stations set to "OFF" will water automatically at all times and the stations set to "ON" will be controlled by the rain switch. IE: The stations set to "ON" will not water automatically with the rain switch in the "WET" mode. To set individual stations to "ON"

press **+** button and advance by pressing **→**.

Continue until all stations are set "ON" for rain sensor control or "OFF".

The display will show:

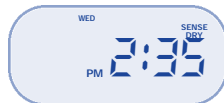

BYPASS SWITCH - RAIN SENSOR

To override the rain switch move the bypass switch to the "OFF" position. This position will enable automatic watering and manual operation to **Run Program** to occur at any time regardless of whether the sensor is wet or dry.

NOTE: Both the System Test and Run Single Station will work regardless of whether the sensor is wet or dry.

RAIN OFF MODE

To stop the automatic watering cycles during winter, **turn** the dial to the **Off** position. The word "Off" will appear in the display. This means the automatic schedules will not come on, but the programmed information is still retained in the memory.

To reactivate the automatic schedule, **turn** the dial back to the **Auto Run** position.

NOTE: If a rain switch has been connected, it will turn the stations set to rain sensor control, OFF. This happens automatically when the switch is wet.

WATER BUDGETING & SEASONAL ADJUSTMENT

The automatic station run times can be adjusted by percentage as the seasons change. This will save time and money as the run times can be adjusted quickly in spring, summer and fall to reduce the amount of water used.

Ensure that the dial is in the **Auto Run** position,

press the **←** & **→** buttons simultaneously.

The display will show:



Displayed is the word "Budget" and "100%". This represents current automatic watering run times as being 100%. The percentage budget can be set in 25% increments from 25% up to 150%.

Example: 50% reduces watering by half.

To adjust in 25% increments, use **+** or **-** buttons.

To return to the clock press the **←** and **→** buttons simultaneously.

The word Budget will be displayed to indicate that the water budgeting feature is in use.

OTHERFEATURES

FAULT FINDING GUIDE

SYMPTOM	POSSIBLE CAUSE	SUGGESTION
No display.	Faulty transformer. Fuse blown.	Check fuse. Check field wiring. Check transformer.
Single Station not working.	Faulty solenoid coil.	Swap faulty station wire on controller terminal block with known working station wire. If the faulty valve still does not work on the known working connection then the solenoid coil is faulty. The panel may need to be repaired.
Fuse blows.	Incorrect wiring or bad wiring connections.	Check wiring and connections.
No automatic start.	Incorrect programming or fuse.	If unit works manually check programming. Check fuse and field wiring.
Buttons on keypad not responding.	Short on keypad or Programming not correct.	Check instruction book to ensure programming correct. If keypad still not responding return panel to supplier or manufacturer.
System coming on at random.	Too many start times entered on automatic programs.	Check number of start times entered on each program. If programming is correct return panel to supplier or manufacturer.
More than 1 station coming on at once.	Damaged main output driver chip.	Check wiring and swap faulty station wire(s) on controller terminal block with known working station wire. If the same outputs are still locked on, return panel to supplier or manufacturer.
Pump start chattering.	Faulty relay or pump contactor.	Electrician to check voltage on pump relay or contactor.
Display cracked or missing segments.	Display damaged during transportation.	Return panel to supplier or manufacturer.

INSTALLATION INSTRUCTIONS

MOUNTING THE CONTROLLER

Install the controller near a 120VAC outlet, preferably located in a house, garage or other covered area. For ease of operation, eye level placement is recommended.

Ideally, your controller location should not be exposed to rain or areas prone to flooding or heavy water.

INBUILT MODEL:

The inbuilt controller unit is an OUTDOOR MODEL and can be exposed to light rain & is weatherproof.

Fasten the controller using the two mounting holes positioned externally on the top, and the additional hole positioned internally under the terminal cover.

ELECTRICAL HOOK-UP

WARNING

1. All electrical work must be carried out in accordance with these instructions following all applicable Local, State and Federal codes, or warranty will be void.

2. Disconnect main power supply before maintenance work to controller or valves and when connecting and disconnecting field wiring and pump or master valve hook-ups.

INSTALLATION INSTRUCTIONS

FIELD WIRING CONNECTIONS

PREPARATION

1. Prepare wires for hook-up by cutting the wires to the correct length and stripping approximately .25 in. (6.0mm) of insulation from the end to be connected to the controller.
2. Ensure terminal block screws are loosened sufficiently to permit easy access for wire ends. Insert stripped wire ends into the clamp aperture and tighten screws. Do not over tighten as this may damage the terminal block.
3. A maximum of 0.75 Amps may be supplied by any output. Check the inrush current of your solenoid coils before connecting more than two valves to any one station.

TERMINAL BLOCK LAYOUT

The terminal block is laid out as follows:
EG: 16 station

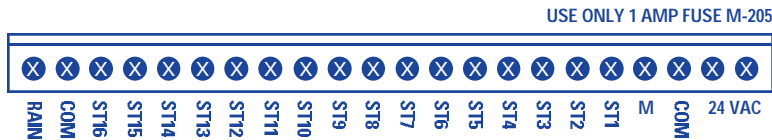

POWER SUPPLY CONNECTIONS

Inbuilt Transformer

It is recommended that the transformer is not connected to a 120V AC supply which is also servicing or supplying motors (i.e. Air conditioners, pool pumps, refrigerators, etc.) Lighting circuits are suitable as a power source.

This inbuilt transformer model, is suitable for outdoor installation as the housing is weatherproof and UV stabilized. However, it is recommended that the unit be installed in an area which is not exposed directly to the weather.

Connections to the unit are as follows:

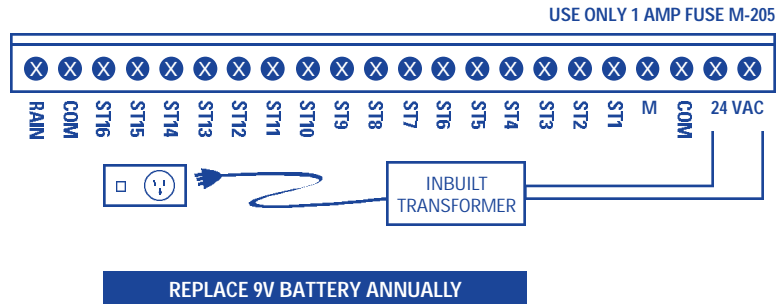

GLOSSARY

24VAC	24VAC Power Supply
RAIN	Rain switch wire input
COM	Common valve wire input
M	Master valve or pump start active wire
ST1 to ST16	Station (Valve) active wire connection

INSTALLATION INSTRUCTIONS

PUMP START RELAY & MASTER VALVE CONNECTIONS

This controller does not provide main power for a pump. Complete this section for master valve and pump start relay installation. Connect the master valve or pump start relay wiring to the "M" and "COM" controller terminals as shown below.

WARNING

For systems supplied with water from a Pump, unused stations must be connected back to the last used station to eliminate the possibility of the pump running against a closed head. Failure to do so could lead to pump damage or injury.

The diagram shows an 16 Station Controller:

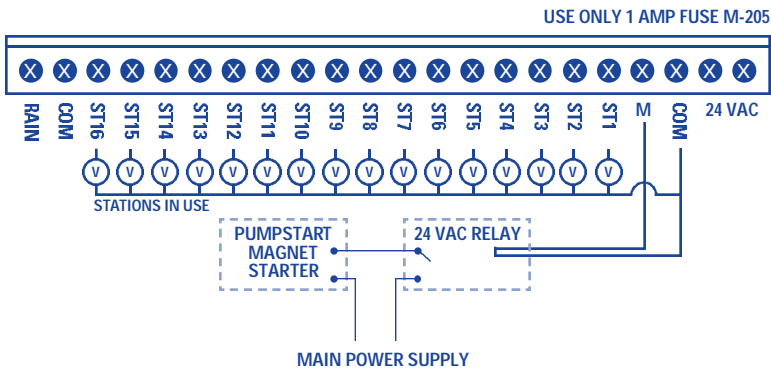

CONNECTION OF VALVES & RAIN SWITCH

Up to three 24VAC Solenoid Valves can be connected to each station output and wired back to the common (COM) thus:

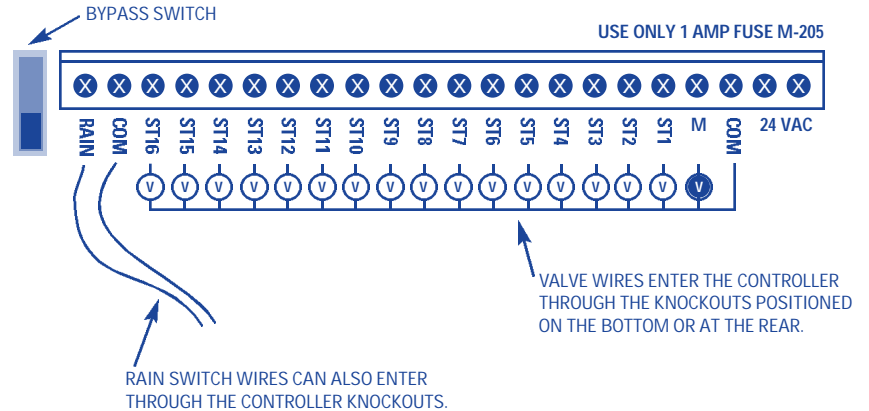

RAIN BYPASS SWITCH

OFF - This position will bypass the rain switch if it is wet.

ON - This position will allow the rain switch to turn stations OFF when in the wet mode.

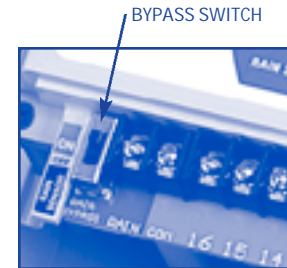

ELECTRICAL CHARACTERISTICS

ELECTRICAL OUTPUTS

Power Supply

MAIN SUPPLY: This unit runs off a 120VAC 60Hz delivering 24VAC through a 30VA rated transformer.

Electrical Power Supply:

Input: 24Volts AC 60Hz.

Electrical Outputs: Maximum of 1.0 AMP

TO SOLENOID VALVES:

24 VAC 50/60 Hz 0.75 AMPS max.

NOTE: Up to 3 valves with the inbuilt model.

TO THE MASTER VALVE/PUMP START:

24VAC 0.25 AMPS max.

NOTE: Transformer and fuse capacity must be compatible with output requirements.

Overload protection:

Standard 20mm 1 AMP fuse.

Power failure:

9 Volt block type battery maintains clock and programs for up to 4 weeks.

Wiring:

The output circuits should be installed and protected in accordance with wiring rules.



SERVICING THE CONTROLLER



THE CONTROLLER SHOULD ALWAYS BE SERVICED BY AN AUTHORIZED AGENT.



Follow these steps:

1. Turn main power off to the controller.
2. Disconnect 24 Volt power leads at the controller 24VAC terminals.
3. Clearly mark or identify all valve wires according to the terminals they are connected to, (1 to 16). This allows you to easily wire them back to the controller, maintaining your valve watering sequence.
4. Disconnect valve wires from the terminal block.
5. Remove the complete panel from the box by unscrewing the two screws at both ends of the terminal block.
6. Carefully wrap the panel in protective wrapping and pack in a suitable box. Return to your service agent or the manufacturer.
NOTE: Tampering with the unit will void the warranty.
7. Replace your controller panel by reversing this procedure. The Controller should always be serviced by an authorized agent.

SPARE WATERING PLANNER

STATION NUMBER		5	11
		6	12
1		7	13
2		8	14
3		9	15
4		10	16
PROGRAM			
	START TIME	WATERING INTERVALS	
1	START TIME 1:		STATION
			RUN TIME (MINUTES)
	2ND START TIME:		STATION
	3RD START TIME:		RUN TIME (MINUTES)
	4TH START TIME:		
2	START TIME 1:		1 9
			2 10
	2ND START TIME:		3 11
	3RD START TIME:		4 12
	4TH START TIME:		5 13
3	START TIME 1:		1 9
			2 10
	2ND START TIME:		3 11
	3RD START TIME:		4 12
	4TH START TIME:		5 13
4	START TIME 1:		1 9
			2 10
	2ND START TIME:		3 11
	3RD START TIME:		4 12
	4TH START TIME:		5 13

STATION NUMBER		5	11
		6	12
1		7	13
2		8	14
3		9	15
4		10	16
PROGRAM			
	START TIME	WATERING INTERVALS	
1	START TIME 1:		STATION
			RUN TIME (MINUTES)
	2ND START TIME:		STATION
	3RD START TIME:		RUN TIME (MINUTES)
	4TH START TIME:		
2	START TIME 1:		1 9
			2 10
	2ND START TIME:		3 11
	3RD START TIME:		4 12
	4TH START TIME:		5 13
3	START TIME 1:		1 9
			2 10
	2ND START TIME:		3 11
	3RD START TIME:		4 12
	4TH START TIME:		5 13
4	START TIME 1:		1 9
			2 10
	2ND START TIME:		3 11
	3RD START TIME:		4 12
	4TH START TIME:		5 13

STATION NUMBER		5	11
		6	12
1		7	13
2		8	14
3		9	15
4		10	16
PROGRAM			
	START TIME	WATERING INTERVALS	
1	START TIME 1:		STATION
			RUN TIME (MINUTES)
	2ND START TIME:		STATION
	3RD START TIME:		RUN TIME (MINUTES)
	4TH START TIME:		
2	START TIME 1:		1 9
			2 10
	2ND START TIME:		3 11
	3RD START TIME:		4 12
	4TH START TIME:		5 13
3	START TIME 1:		1 9
			2 10
	2ND START TIME:		3 11
	3RD START TIME:		4 12
	4TH START TIME:		5 13
4	START TIME 1:		1 9
			2 10
	2ND START TIME:		3 11
	3RD START TIME:		4 12
	4TH START TIME:		5 13

WARRANTY

K-Rain products carry a “LIMITED WARRANTY”. For two (2) years from the date of manufacture, K-Rain will repair or replace (at K-Rain’s option) the product or any part, if the product is found to be defective as to workmanship or material. This warranty does not extend to damage to a K-Rain product resulting from misuse, neglect or abuse, normal wear and tear, or accident, to exterior appearance or color or due to improper installation. This warranty extends only to an original user of a K-Rain product.

IN NO EVENT SHALL K-RAIN BE LIABLE FOR INCIDENTAL OR CONSEQUENTIAL DAMAGES. ALL IMPLIED WARRANTIES ARE LIMITED IN DURATION TO TWO YEARS FOLLOWING DATE OF MANUFACTURE. Some states do not permit the exclusions or limitation of incidental or consequential damages or of implied warranties. Therefore, the above exclusions or limitations may not apply to you.

If a defect arises in a K-Rain product within the warranty period, you should promptly contact your K-Rain distributor or K-RAIN MANUFACTURING CORP. Please allow up to 4 weeks for completion of repairs or replacement and return of product. If a product is replaced, the replacement product is covered only for the remainder of the original warranty period dating from the purchase of the original product.

This warranty gives you specific legal rights, and you may also have other rights which vary from state to state. If you have any questions concerning the warranty or its application, please write:

K-Rain Manufacturing Corporation
1640 Australian Avenue, Riviera Beach, Florida 33404
Attn: Product Manager.



K-Rain Manufacturing Corp.
1640 Australian Avenue, Riviera Beach, FL 33404

krain@k-rain.com
www.k-rain.com

