

















Indoor or Outdoor	Indoor Only
E-3	E-3i
E-6	E-6i
E-9	E-9i
E-12	E-12i

## INTRODUCTION

Thank you for purchasing a Rain Bird E-Class irrigation system Controller. This manual describes how to install and operate your controller. Installation instructions are in the last section. Please read the instructions carefully and keep this manual in a handy location for future reference.

## PROGRAMMING CONTROLS

The following is a key to the buttons and icons on the E-Class controller faceplate.

 OFF	 WATER BUDGET	 TIME/DATE OPTION
 AUTOMATIC MODE	 SET MONTH	 PLUS (add): +
 DATE/TIME	 SET DATE	 MINUS (subtract): -
DAY CYCLE: <b>DAY CYCLE</b>	 SET TIME	 SELECT PROGRAM: ABC
WATER DAY: <b>WATER DAY</b>	 MANUAL STATION(S) START	 ENTER: <b>ENTER</b>
START TIME: <b>START TIME</b>	 MANUAL PROGRAM (CYCLE) START	 CONTROLLER KNOB (PROGRAMMING DIAL)
 STATION RUN TIME	<b>TEST</b> TEST PROGRAM	

## WHAT MAKES UP A PROGRAM?

**DAY CYCLE:** The number of days before the cycle repeats, i.e., 7-day cycle: one week long; 3-day cycle: once every three days.

**WATERING DAYS:** set weekdays ON or OFF as watering days (7-day cycle). Set "Today's" number within the cycle (1 through 6-day cycles).

**START TIME:** The time of day that the program begins. This is the time that the first station in the program begins watering. All other stations in the program then follow in sequence, AUTOMATICALLY.

**STATION RUNTIME:** The number of minutes that each station runs.

### I. SET YEAR, DATE AND TIME

1. Turn the controller knob to DATE/TIME.
2. The year 1996 will flash in the display. Press + or - to set to the current year.
3. Press **ENTER** to enter your selection.
4. The digits for the current month will now flash (01). Press + or - to set to the current month.
5. Press **ENTER** to enter your selection.
6. The digits for the current day will now flash (01). Press + or - to set to the current day.
7. Press **ENTER** to enter your selection.
8. The digits for the current hour will now flash (00). Press + or - to set to the current hour.
9. Press **ENTER** to enter your selection.
10. The digits for the current minute will now flash (00). Press + or - to set to the current minute.
11. Press **ENTER** to enter your selection.

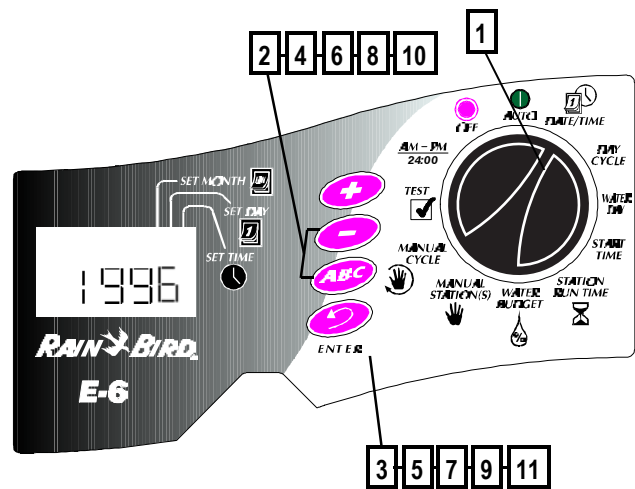

### II. SET REPEATING DAY CYCLE

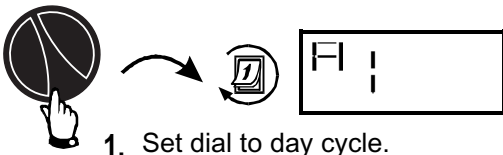

1. Set dial to day cycle.

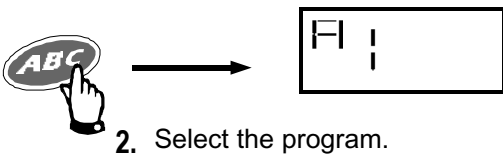

2. Select the program.



3. Select the day cycle and follow the applicable instructions.

## AVAILABLE DAY CYCLES

Follow the next step for the cycle you choose.

1. 7-day (weekly) repeating cycle  
Skip to step III



2. 1-day through 6-day cycle i.e., 3-day cycle = water on day #1, skip #2 and #3, and then start over. In the 1-day through 6-day cycles, day #1 is always the only water day.  
Skip to step III



3. EV = Waters on EVEN dates only  
Skip to step IV



4. Od = Waters on odd dates only  
Skip to step IV



5. Od 31 = Waters on odd dates but not the last odd date of any month  
Skip to step IV

## III. SET WATERING DAYS

### 7 DAY CYCLE

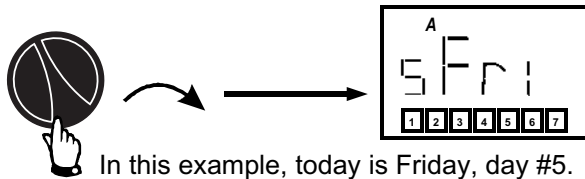

In this example, today is Friday, day #5.

1. The program appears with today's number and abbreviation. The seven weekdays are displayed as a row of numbers. For example Monday is #1, Tuesday is #2, etc.

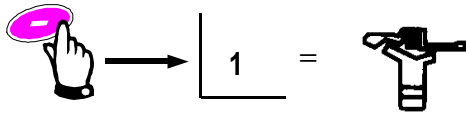

2. The square around a day's number means it is a water day. To turn a weekday OFF as a water day, press - .

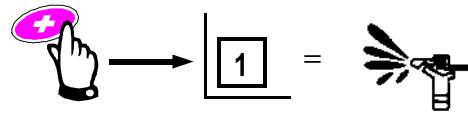

3. To turn a weekday ON as a water day press + to put it back to its square.

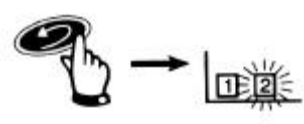

4. Use the ENTER button to move along the row of days and use + or - to set each weekday ON or OFF. When done go to step IV.

### 1-DAY THROUGH 6-DAY CYCLES

In the 1-day through 6-day cycles the only water day is always Day #1 (shown in its square).

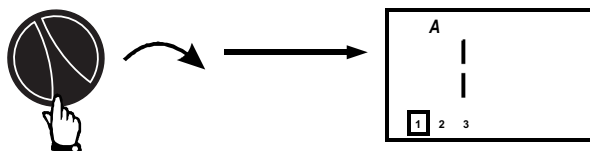

EXAMPLE OF A 3-DAY CYCLE.

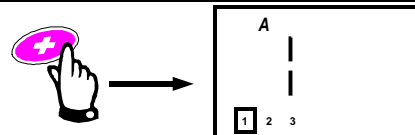

Use + to set "Today" number. In this example, the "Today" number was set to Day 3. Tomorrow, Day 1 will be the water day as the cycle starts over. Now go to step IV.

## IV. SET WATERING START TIMES

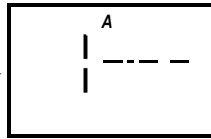

1. Press **SELECT PROGRAM**.

2. The program letter and "1" for Program Start Time One appear.



AM 12:00 ↔ PM 1:59

2. Set the time that you want the program to start.

**Note:** Remember, if you want all the stations on the program to run only once each watering day, enter only one start time for the program.

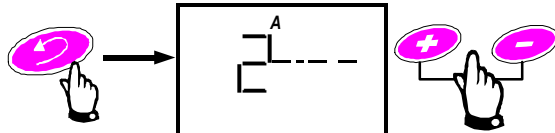

You can repeat entire programs several times each water day. Press **ENTER** and repeat step 2. There are 6 program start times available.

## TO DELETE A START TIME

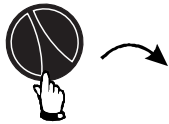

1. Turn dial to **START TIME**.



2. Press **SELECT PROGRAM**.



3. Repeatedly press ENTER until the start time you want to delete appears in the display.

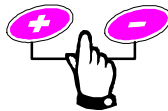

1:59 PM | --- | 12:00 AM

4. Move the start time to the blank screen just before midnight.

The E-Class controller automatically arranges start times in the correct order. When a start time is deleted, its empty gap is filled by the next later start time.



5. Turn the dial back to AUTO.

## V. SET STATION RUN TIMES

In this step you decide how long each STATION WILL RUN.

EXAMPLE:

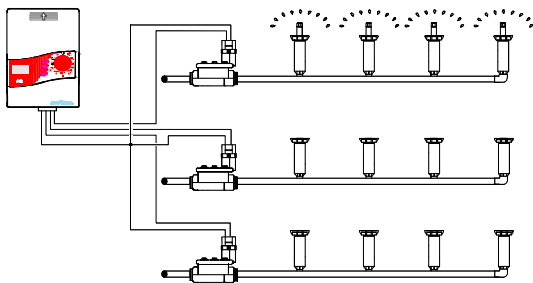

STATION 2 will begin watering when station 1 is done.

If station 3 is in the same program (with #1 and #2) it will run after STATION 2 is done, etc.

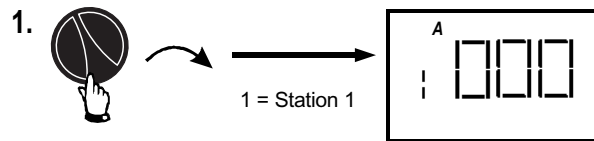

2. Press **SELECT PROGRAM**.

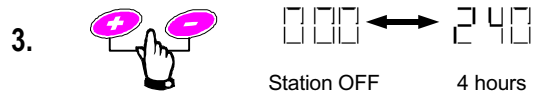

3. SET the station's duration (running time) in minutes.

## V. SET STATION RUN TIMES - CONTINUED

4.

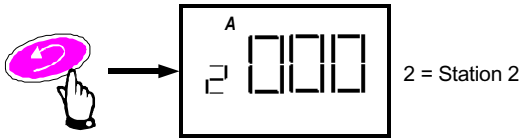

Press ENTER to move to the next station.

5.

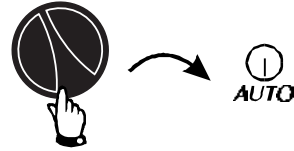

EACH TIME you give a STATION A RUNNING TIME length you have added it to the Program. When you are done, turn it back to AUTO.

When you have finished STEP V, you have completed the AUTOMATIC schedule for the Program. If you want to set up another schedule, press the ABC button until the Program letter you want appears (A, B, or C) and then start over with STEP II.

## VI. ADJUST WATER BUDGET PERCENTAGE

WATER BUDGET allows you to increase or decrease watering time length for all stations on a Program with just one adjustment.

1.

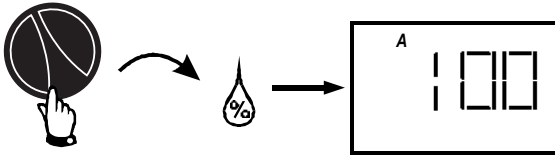

2.

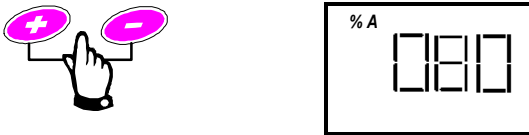

3.

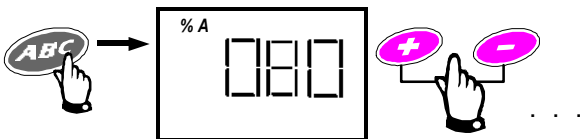

TO SET ANOTHER PROGRAM'S WATER BUDGET  
**100** = 100% station time lengths. Normal running length (NO WATER BUDGET)  
**70** = 70% of normal time lengths, perhaps for cooler weather.  
**200** = Hot, dry weather - Double (200%) the normal time lengths for all stations on the Program.

4.

TO CANCEL A WATER BUDGET, set the % to 100.  
**000** = Individual Program OFF (0%)  
**%A, %B, %C**  
 Indicates which Programs have WATER BUDGET in effect.

5.

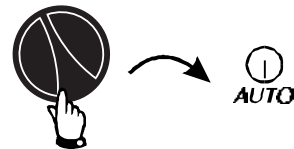

## VII. TO MANUALLY OPERATE STATION(S)

MANUAL STATION(S) allows you to manually run any station or stations you want for the number of minutes you want. Normal station running times in the Automatic Programs are not affected.

1.

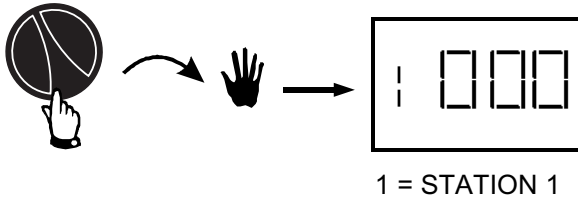

2.

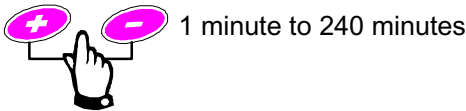

3.

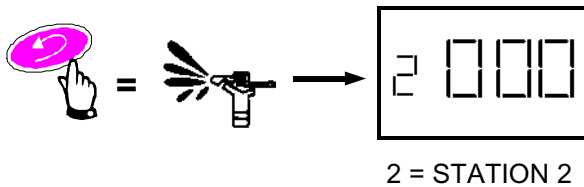

Use **ENTER** to start the first station in your Manual run and to move upward through the stations.

4.



STOP AT ANY STATION YOU WANT, use + or - to set a running time for it. Use **ENTER** to put the station in line with the others and to move upward again. Make sure to press **ENTER** after setting the time on the last station you have chosen.

5.

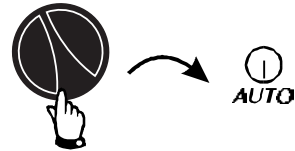

Turn the dial back to AUTO. The controller will run the station(s) you selected, and then return to automatic mode and wait for the next start time.

6. TO STOP MANUALLY STARTED STATION(S)

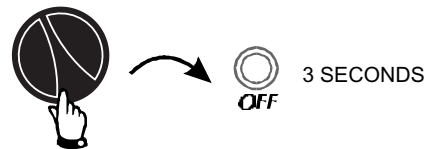

7. Turn the dial back to AUTO.

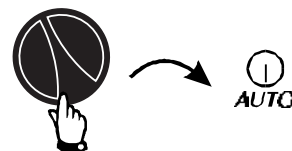

## VIII. TO MANUALLY OPERATE PROGRAM(S)

1.

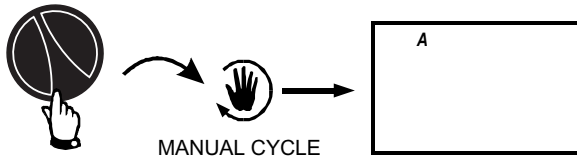

Dial to Manual Cycle.

2.



Select the Program

3.



Start the Program using the ENTER button. If you want to “stack” one of the other programs to run following the first, repeat #2 and #3 above. The letter (A, B, or C) for the first “stacked” Program will blink.

4.

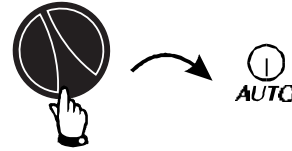

5. TO STOP MANUALLY STARTED PROGRAMS(S)

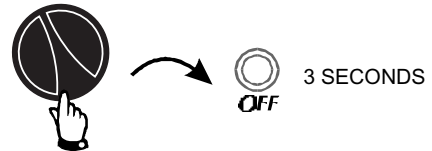

6.

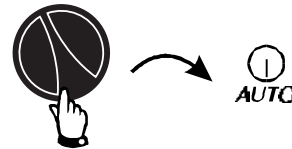

## IX. TO RUN THE TEST PROGRAM

1.

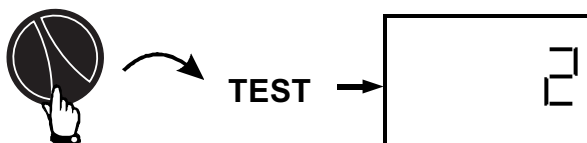

2 = 2-minute test per station

2.

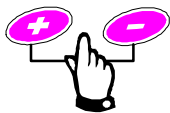

Set the minutes of running time from 1 - 10

3.



Press “Enter” to start the test cycle

4.

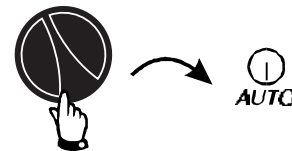

Turn the dial to AUTO. Each station will run for the time you set. If a station has no running time in any of the Automatic Programs, it will not operate during the TEST.

### MANUAL ADVANCE

You can manually advance through the stations of any program by setting the dial to AUTO and repeatedly pressing the **ENTER** key.

## X. TO TURN CONTROLLER OFF

1.

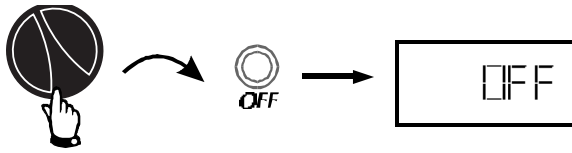

No watering occurs, however, the controller keeps the time, date, and your program in memory.

2.

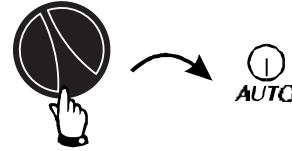

Return the controller to automatic operation.

## XI. TO SET DATE/TIME DISPLAY

1. Option

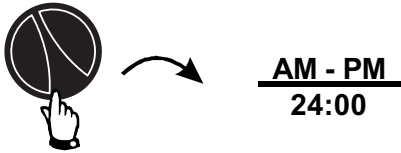

To change between the English Time/Date system and the European method use this dial position and the ENTER button.

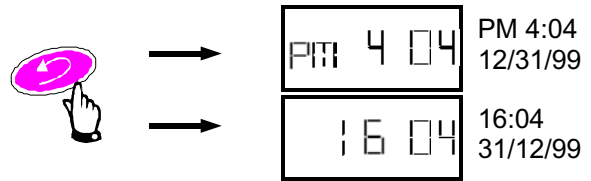

## XII. MOISTURE SENSOR SETTING (IF INSTALLED)

You can tell the controller to stop watering when an attached sensor reaches its “wet” condition. You can also override a sensor if needed. When a sensor system interrupts watering, the controller continues its programs, the valves remain off.

If no sensor is attached to the controller, leave the wire loop in place that connects the two sensor screws.

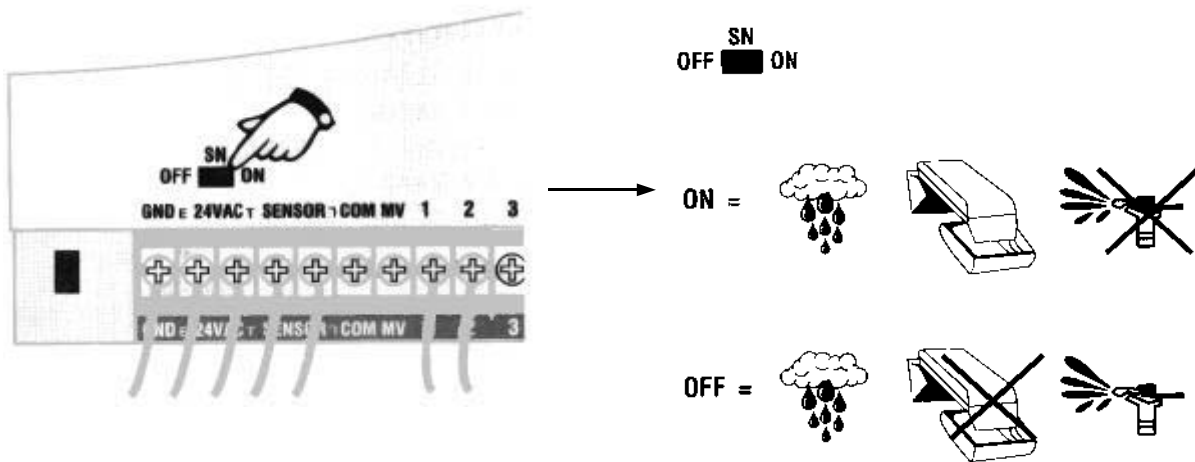



---

### XIII. ERASE ALL PROGRAMMING

With the dial at Auto, open and remove the lower cover. With a metal object, momentarily connect two contacts at the back of the RESET Tunnel. When the display goes blank, remove the metal object. You can now reprogram the controller.

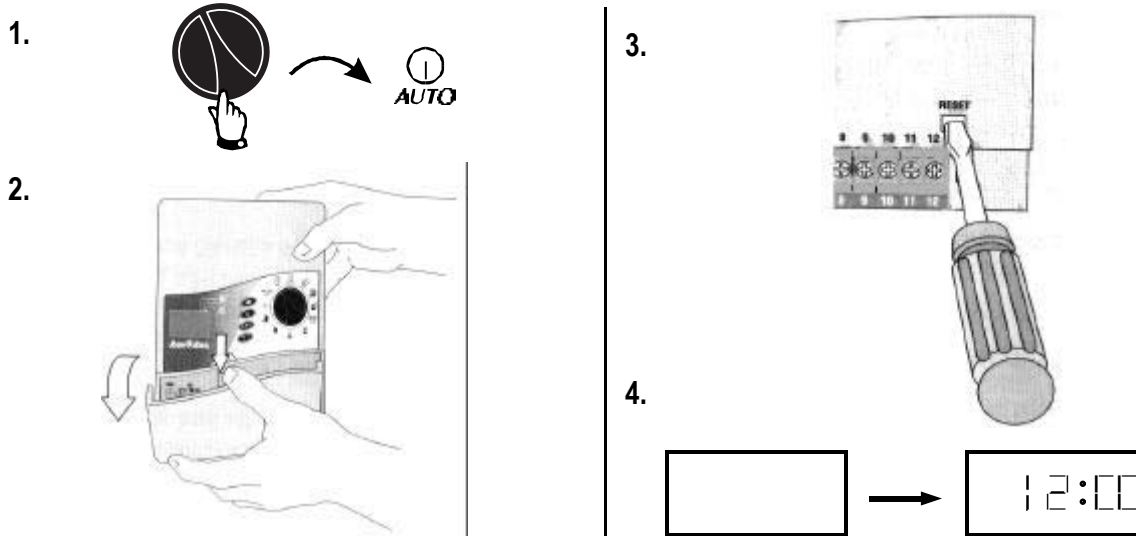

---

### XIV. BACK-UP MEMORY (NO BATTERIES REQUIRED)

#### During a power outage

1. The display is blank
2. Time/Date/all Programs retained for 24-30 hrs.
3. Default Program if memory is lost and power returns:  
Date: 01/01/96  
Time: 12:00 AM  
Start Time: 8:00 AM  
All Stations: On Program A  
Day Schedule: 7-day, water everyday  
Station Timing: 10 minute each



The default program disappears as you start to re-program.

---

### XV. TROUBLESHOOTING

#### DIAGNOSTIC CIRCUIT BREAKER (No fuse required)

If the controller detects an electrical short circuit on one of the sprinkler system's station wires or valve solenoids, the controller automatically shuts off the station with the fault. After 30 - 40 seconds, while the E-Class unit is checking again to confirm the fault, the controller advances to the next station in the program.

Every 3 seconds, the controller will display the problem station's number with the letters "Err". The E-Class controller will continue to run each operable station in the program. As each station is running, the controller (at an alternate 3-second interval) will display the station's number and time-to-go.

When the controller finishes the program, it will continue to display the problem station's number and "Err".

At this point, you should isolate and repair the short circuit. Short circuits are most often found to be in the valve solenoid (the plastic-encapsulated coil on the valve with the two wire leads) or in the wire connectors to the valve leads. After you have found and repaired the short, turn the dial to AUTO and press **ENTER** to clear the "Err" message from the display. You can then operate the station manually to see if it works properly.

## TROUBLESHOOTING GUIDE

SYMPTOM	CAUSE	CORRECTION
Display shows "Err"	1. The automatic circuit breaker has found an electrical problem.	<p>The "Err" in the display indicates a short circuit or an electrical overload on a particular station. The station's number should also be displayed; for example "2 Err" means the problem is in Station Two's circuit.</p> <p>Usually, the short circuit is in the solenoid on the electric valve, but short circuits can also occur in the wire connectors at the valve. Occasionally, nicked or "skinned" field wires can cause a short. A large pump start relay can also produce a momentary overload that may be detected by the controller.</p> <p>Locate and repair the cause of the short circuit. See the "Diagnostic Circuit Breaker" on page 9 for instructions on clearing the problem indicator from the display and testing the station.</p>
Display shows "Err" for a few seconds and then the station in operation for a few seconds.	2. Same as Cause #1.	See correction for Cause #1.
Display is blank.	<p>3. Power is off to the controller</p> <p>4. If the controller is still receiving power, an electrical surge exceeding the controller's built-in surge protection may have damaged the controller's micro-processor.</p>	<p>Re-establish power to the controller. If the current time is not shown or your program is no longer in the memory, reprogram the controller.</p> <p>Open the lower access cover and erase all programs as described on page 9.</p> <p>If the display remains blank, the controller may be permanently damaged. In the U.S.A., Call 1-800-247-3782 for a service referral.</p>
Display shows numbers and letters, but is not counting or advancing.	5. Same as Cause #4.	See correction for Cause #4.
Watering will not start.	<p>6. Programming incomplete.</p> <p>7. Sensor function may be preventing irrigation.</p> <p>8. Water supply may be shut off.</p>	<p>Check to see if:</p> <ul style="list-style-type: none"> <li>• program start time is correct</li> <li>• stations are assigned to the program</li> <li>• the date and time are correct in the display</li> <li>• AM and PM settings are mixed up</li> <li>• the dial is set to OFF instead of AUTO</li> </ul> <p>Set sensor switch to OFF position and manually start a station.</p> <p>Check to see if water supply line has pressure.</p>
Watering will not stop.	<p>9. Programs may have accidentally been set to overlap.</p> <p>10. A valve is stuck in the open position.</p>	<p>Check to see if another program's start time came due during the previous program's cycle. The overlapped program would immediately follow the earlier one. Change programming if necessary.</p> <p>Turn dial to OFF and wait 10-20 seconds. If the irrigation does not stop, shut off the valve manually and repair the valve.</p>

---

## XVI. INSTALLING THE CONTROLLER

NOTE: Even though directions for connecting the wiring to the controller are provided in this manual, local electrical codes may vary in what is required for proper and safe installation. This controller **must** be installed in **compliance with local electrical codes**

Rain Bird E-Class controllers are available in either indoor or outdoor models. Indoor models have a separate transformer. Outdoor models have a built-in transformer and a separate plastic junction box.

### CHOOSE LOCATION

Choose a mounting location near an electrical power source. For the indoor controller, the mounting location must be within 5' (1.5 m) of the electrical wall outlet.

For the outdoor controller, the wires from the source of electrical power to the controller need to be protected in a conduit that meets local electrical code requirements for high voltage (either 120 or 230 volt) circuits. Even though the outdoor model is housed in a weather-resistant cabinet, choose a location that is somewhat sheltered if possible.

Note: The sliding door (cover) on the outdoor models must be left in the down (closed) position to provide weather and water spray protection to the controller.

---

### MOUNT CONTROLLER

Note 1: Allow 7-1/2" inches of clearance above the top of the controller (or 8-1/2" above the upper edge of the wall mounting bracket) so you will have room to slide the controller down over the wall mounting bracket (on models with a sliding door, this overhead clearance also allows the door to be removed or reinstalled).

Note 2: For indoor units that do not have a sliding door, the overhead clearance can be reduced to 2" above the top of the controller (or 3" above the top of the wall mount bracket). This lower clearance may be needed, for example, if the only mounting location was for the controller under a shelf on the garage wall. See note 3 on page 12 on how to mount the controller using this lower clearance.

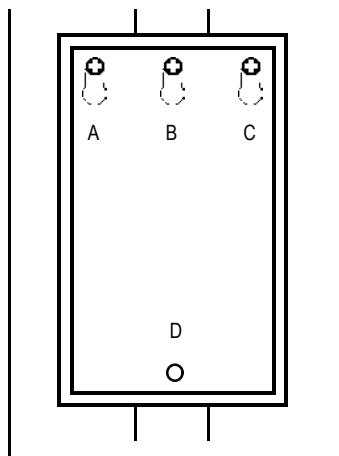

1. Holding mounting bracket to the wall or other mounting surface, at about eye level, mark, with a pencil, the location for screws or fasteners at the top of the narrow slot(s). For a flat surface, use keyhole slots "A" and "C" for the fasteners. If you are mounting the controller on a narrow post or exposed wall stud, use keyhole slot "B". The bracket's upper slots are sized for the head of a Number 8 screw, however, you will need the type of fasteners appropriate for your wall's surface. Remove the bracket and drive the fastener(s) into the wall where you made the marks in the upper slot(s) only. (See illustration.) **DO NOT drive a fastener through hole "D" at this time.** Leave 1/4" of the fastener's shaft showing between the wall and its head. Hang the wall bracket on the fasteners by the upper slot(s). Tighten or loosen the fasteners for a snug fit that will still allow the bracket to slide up and off the fasteners should it ever be necessary. With a nail or punch, tap a pilot hole in the wall through the center of hole "D".

2. Pull upward on the sliding door (for controllers with doors) to the latched position that exposes the face panel controls and then with a firmer tug pull the door upward and off the controller. Remove the lower access cover by placing your fingers under the door at the bottom of the controller and your thumb on top of the access door on its latch hook. Then, press gently down on the latch hook and swing the door outward and downward away from the controller. Turn the controller upside down on the edge of a flat surface (see illustration).

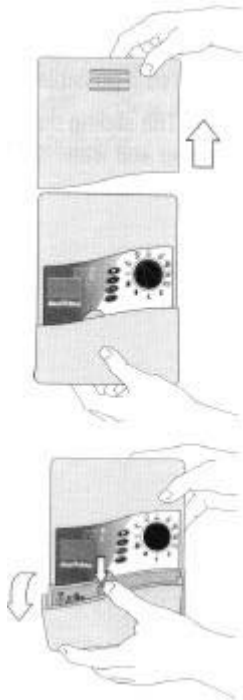

3. Place a flat blade screwdriver in the groove of the knockout labeled "A" in the illustration. With the palm of your hand, strike the end of the screwdriver handle to punch in one side of the knockout. Repeat the process on the other edge of the knockout and remove it. One knockout hole is sized for 3/4" conduit. If the size and number of valve wires require more than 3/4" conduit, punch out the second knockout for 1" conduit instead.

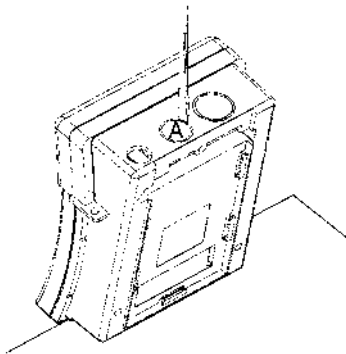

4. Slide the controller down over the mounting bracket until lower mounting hole "D" aligns with the hole in the back of the terminal strip compartment. You may want to wait until after you have cut your wire conduits to length before driving the last mounting screw through the aligned holes to secure the controller to the wall or stud.

Note 3: For installations with low overhead clearance (and with no controller sliding door), slide the wall bracket up and off the wall. Slide the

wall bracket up into its tracks on the back of the controller and, together, mount the bracket and controller back on the wall. Make sure that hole "D" in the bracket and the hole in the back of the lower compartment of the controller are aligned with each other and with the pilot hole in the wall's surface.

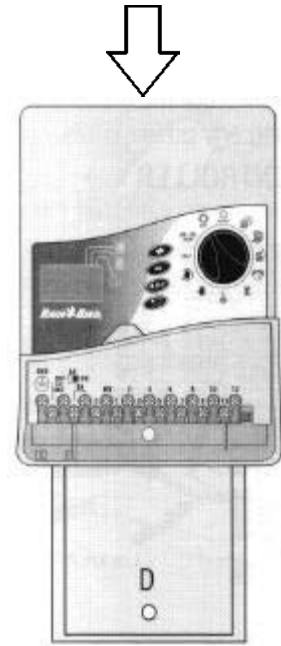

## CONNECT MAIN POWER WIRES

**WARNING:** Make sure the power source is off before connecting any power wires.

## OUTDOOR CONTROLLER

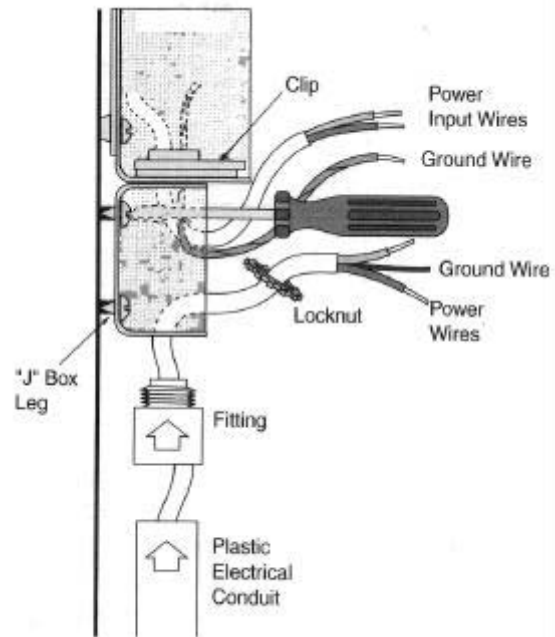

The illustrated "side view" shows how the controller, "J" box, conduit and fitting are used for outdoor installations.

The slide-in clip holds the "J" box to the controller, however, the "J" box must be screwed to the wall.

Cut both the power supply conduit to the right length and your valve wire conduit.

## U.S. VERSION, 117-120 VAC, 60HZ)

1. Unscrew and remove the cover of the junction box and remove the clip that is supplied with it. Carefully punch in and remove knockout "E" in the end of the junction box and punch out the two small holes "F" & "G" (see illustration).

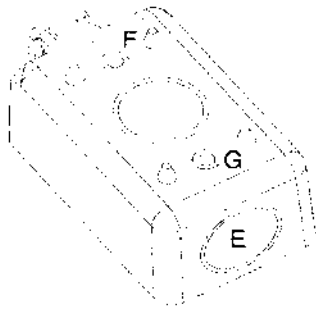

2. Cut the power input wires from the controller and the supply wires from the power source to a convenient length, approximately 3" (75 mm) for making wire connections. Strip approximately 1/2" (12.5 mm) of the installation from the end of each wire (see illustration).

3. With code-approved wire connectors, connect the green wire (sometimes this a completely bare, copper wire) from the power source to the green/yellow wire from the controller. In a similar manner, connect each of the two remaining power source wires to one of the controller's input wires (see illustration).

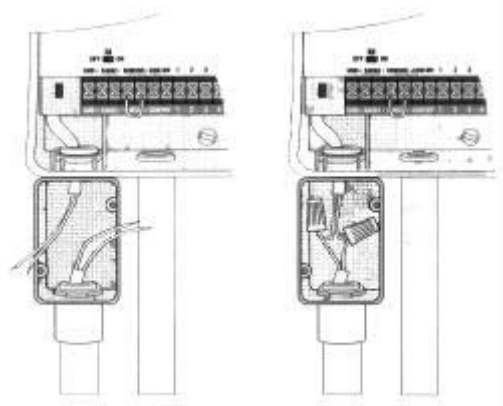

4. Carefully coil or bend the wires to fit them and their connectors into the junction box. Reattach the cover to the junction box.

## OUTDOOR CONTROLLER (INTERNATIONAL VERSION, 230 VAC)

The main power connections for the 230 VA. versions of the E-Class controller are very similar to the U.S. version described previously. The only exception is that there are only two main power input wires coming from the controller. Connect each of these two input wires to one of the power wires coming from the 230 VAC power source (see illustration). Use wire connectors that meet local electrical codes.

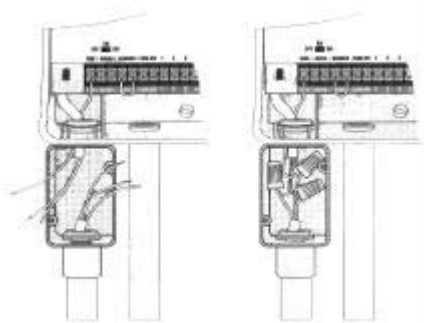

## INDOOR CONTROLLER (117-120 VOLT 60 HZ VERSION)

1. Before connecting the external transformer to the controller, make sure the transformer is **NOT** plugged in.

2. Feed the wires from the transformer through the left-hand hole in the bottom of the controller. Pull about 10" (25.5 cm) of the wire out through the front of the compartment. To provide strain relief, loop the wire into a simple overhand knot, leaving the ends of the wire between 3" and 4" (7.7 cm and 10.2 cm) beyond the knot. Pull the excess wire back out of the bottom of the controller until the knot reaches the hole (see illustration).

3. Connect the green wire from the transformer to the far left screw (GND) on the terminal strip. Connect each of the two remaining wires to one of the screws labeled "24 VAC".

4. Plug the transformer into any standard, 3-prong 117 VAC grounded wall outlet.

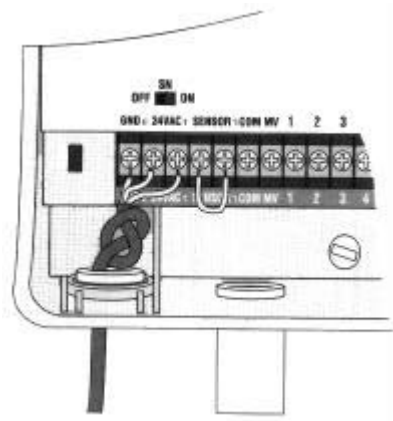

## INDOOR CONTROLLER (230 VOLT 50HZ INTERNATIONAL VERSION)

Because of the wide variety of plug patterns used for electrical wall outlets around the world, the indoor controller provides a separate transformer with a two-wire, 230 VAC input to which you can attach the proper plug. After attaching the plug to the input wires, do not plug the transformer in.

The transformer has plastic loops that allow you to screw it to the wall surface at a convenient location. The two 24 VAC output wires are to be attached to the "24 VAC" screws before plugging in the power cord. (See illustration.)

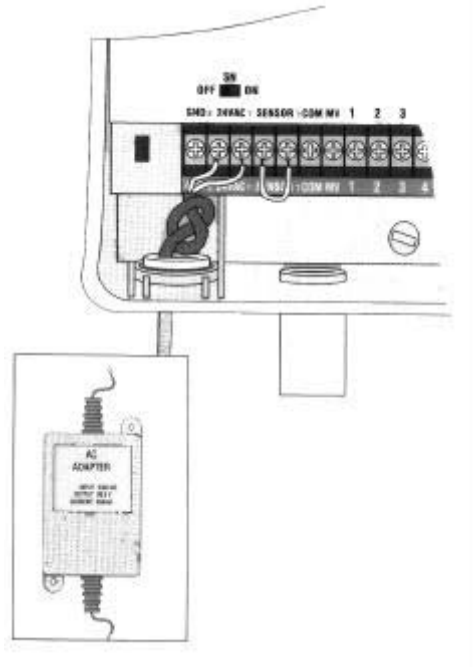

## CONNECT FIELD WIRES TO REMOTE CONTROL VALVES

NOTE: The E-Class, residential controller is designed to work best with #18 gauge, multi-conductor cable that is approved for low-voltage, direct burial applications. These cables usually have a white insulated wire for Valve Common and then a different color wire for each station valve, all contained within an outer jacket.

The wires coming back to the controller from the electric valves in the field can be routed into the controller through the larger hole(s) in the bottom of its cabinet. For a clean, professional look to the installation, the hole size is for a 3/4" PVC conduit to house the wires (or for 1" PVC). The upper ends of the conduit(s) should end about 1/4 inch inside the bottom of the controller.

If using a pump: connect unused stations to the closest used ones.

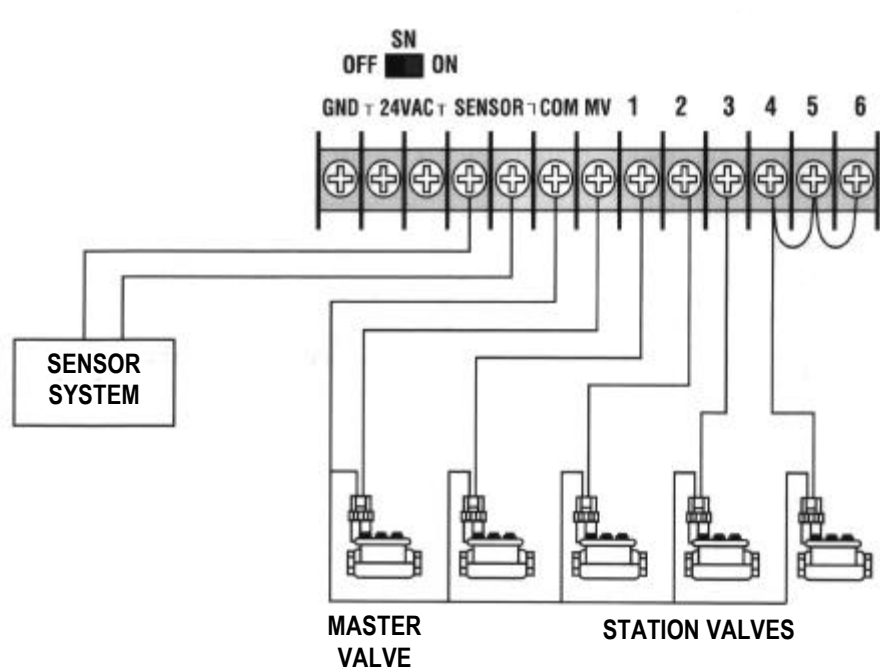

## **CONNECT FIELD WIRES TO REMOTE CONTROL VALVES - *continued***

The illustration shows the various wire runs and connections between the controller and other devices. Each valve to be controlled by the E-Series controller should have its own, separate power wire. Connect one end of the power wire to a numbered station terminal on the controller's terminal strip. Connect the other end of the power wire to one of the wire leads on the valve solenoid. The wire connectors at the valves must be water-proof.

Connect the white valve common wire to the "C" terminal on the terminal strip. The valve common wire should follow the route out along the valve locations and should connect to the remaining wire lead on each valve.

If your system includes a master valve on its main line supply or a 24-volt-activated pump start relay (for activating a pump during irrigation) connect a wire from the device to the "MV" terminal on the controller. (The controller does not provide the main power for a pump.) Connect the other wire lead on the device to the valve common wire. If you are connecting a pump start relay, follow the wiring directions that came with the relay.

**4. Warning for Systems Using Pump Start Relays:** If you are using the pump start/MV circuit to turn on the pump for your system, you must connect any unused stations to the last station that does not have a valve connected to it. For example, if you have a 6-station controller and only stations 1-4 are connected to valves in the system, connect terminals 5 and 6 to station #4 with a short wire on the terminal strip. Then, if a prolonged power outage outlasts the controller's memory protection, and the controller activates its default program, when the pump and stations #5 or #6 are running, station #4's valve allows water-flow to prevent the pump from overheating. (See previous illustration on page 14.)

5. If you are not going to connect a sensor system to the E-Series controller, you have now completed the mounting and wiring procedures for the unit. Replace the lower access cover on the controller, and you are ready to begin programming.

## **CONNECT SENSOR**

The E-Class controller is compatible with several types of rain sensors and underground moisture sensor systems.

1. To connect a sensor system to the E-Class controller, first loosen the screws at the two SENSOR positions on the terminal strip, and remove the jumper wire connecting them.

2. Attach one wire to each of the SENSOR positions on the controller's terminal strip. Route the pair of wires out of the controller to the sensor system. Connect the two wires to the two wire leads or terminals on the sensor.

NOTE: Most sensor systems have two wire leads or two terminals designed to connect to the valve common wire. However, you must connect these two leads or terminals to the SENSOR terminals on the E-Class controller.

3. After installing the sensor system and hooking up the sensor wires from the controller, follow the sensor system's directions for placing and connecting moisture probes or setting the rain shutoff level, and making final adjustments.

4. After adjusting your sensor system, set the controller's SENSOR switch to the ON position. See "Moisture Sensor Setting" on page 8 of this manual.

This controller generates radio frequency energy and may cause interference to radio and television reception. It has been type tested and found to comply with the limits for a Class B computing device in accordance with the specifications in Subpart J of Part 15 of FCC Rules, which are designed to provide reasonable protection against such interference in a residential installation. However, there is no guarantee that interference will not occur in a particular installation.

If this equipment does cause interference to radio or television reception, which can be determined by turning the equipment off and on, the user is encouraged to try to correct the interference by one or more of the following measures:

- Reorient the receiving antenna.
- Move the controller away from the receiver.
- Plug the controller into a different outlet so that the controller and receiver are on different branch circuits.

If necessary, the user should consult the dealer or experienced radio/ television technician for additional suggestions. The user may find the following booklet prepared by the Federal Communications Commission helpful:

"How to Identify and Resolve Radio-TV Interference Problems."

This booklet is available from the U.S. Government Printing Office, Washington, D.C. 20402, Stock No. 004000003454.



Rain Bird Sales, Inc.  
Customer Support Center  
6640 S. Bonney Ave.  
Tucson, AZ 85706  
**1-800-RAIN BIRD**  
(520) 434-6289 FAX

© 1998 Rain Bird Sprinkler Mfg. Corp.  
® Registered trademark of Rain Bird Sprinkler Mfg. Corp.

PN 633659B