

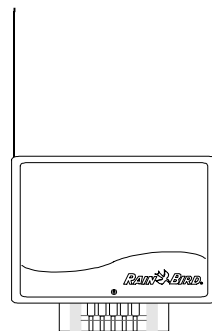

## **RMX-1R Multi-Function Remote Control Receiver (with STX™ Security)**



© 2000 Rain Bird Sprinkler Mfg. Corp. 3/00

### ***Contents***

|   |    |
|---|----|
| FEATURES AND BENEFITS .....             | 2  |
| COMPONENTS OF THE RMX-1R RECEIVER ..... | 4  |
| INSTALLATION .....                      | 6  |
| REGISTERING TRANSMITTERS .....          | 13 |
| CHECK RECEIVER'S MEMORY .....           | 14 |
| ERASE RECEIVER'S MEMORY .....           | 15 |

## FEATURES AND BENEFITS

### Description

The Rain Bird RMX-1R Multi-Function Remote Control Receiver is a two-channel radio-frequency (RF) receiver that lets you send remote commands to Rain Bird remote-ready irrigation controllers.

This function can be useful when you are:

- installing and debugging an irrigation system
- winterizing an irrigation system
- spot-watering
- performing routine maintenance.

This manual describes how to install, test, and troubleshoot the RMX-1R Receiver. The RMX-1R receiver works with either the One-Button Transmitter (RM-1T) or the Keypad Transmitter (RMX-1T). Instructions for using these transmitters are contained in the manual that accompanies each transmitter.

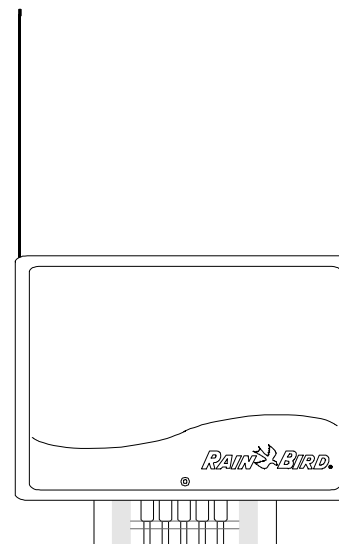

### System Components

To run the Rain Bird RMX-1R Multi-Function Remote System, you need four major components, as shown in the illustration:

- ❶ a receiver
- ❷ a transmitter
- ❸ dual antennae
- ❹ a connection to a Rain Bird remote-ready controller.

**NOTE:** All Rain Bird remote-ready controllers have a radio antenna icon on the face plate (see illustration).

### Tools Required

To install and use the RMX-1R receiver, you will need the following:

- small Phillips-head screwdriver
- pencil
- fasteners, drill bit, and / or screwdriver appropriate for the surface where you are mounting the receiver.

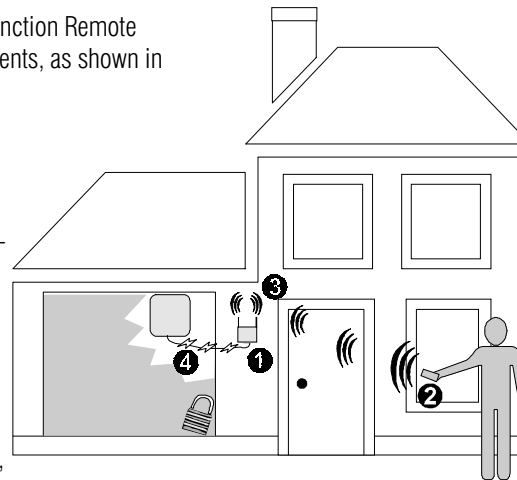

## COMPONENTS OF THE RMX-1R RECEIVER

The cover of the receiver is secured to the body with a screw ( ❶ ).

### Internal Components

Important internal components of the receiver are the LED indicator ( ❷ ) and the Channel 1 button ( ❸ ).

The LED indicator lights when the unit detects RF signals from either a Rain Bird transmitter or other RF sources. The LED also provides information about the number of transmitters registered in the receiver.

**NOTE:** The system uses the proprietary STX™ communication protocol, which prevents the receiver from responding to random RF signals. For example, a neighbor's garage door opener will not start the sprinklers.

The Channel 1 button is used to register transmitters in the receiver. "Registering" a transmitter allows the transmitter to be used with the receiver.

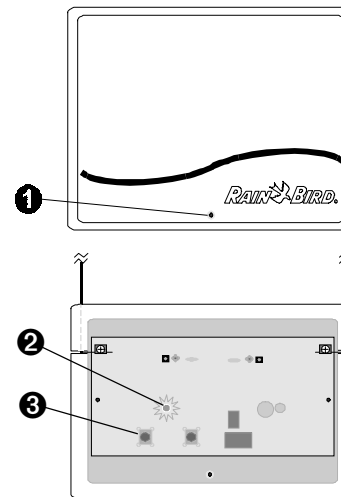

Each transmitter can be registered in multiple receivers, and multiple transmitters can be registered in the same receiver. An RMX-1R Receiver can work with up to 16 transmitters.

### Mounting Bracket

The mounting bracket attaches to a wall or post, providing a convenient “docking station” for the receiver. The mounting bracket offers a variety of installation options:

- When mounting the RMX-1R on a flat surface, use holes 4, 5, and 7.
- If you need to mount the RMX-1R on a narrow post or exposed wall stud, use holes 6 and 7.
- Use holes 8 and 9 for permanent mounting. You can drive two screws through the rear of the receiver cabinet and through the mounting bracket.

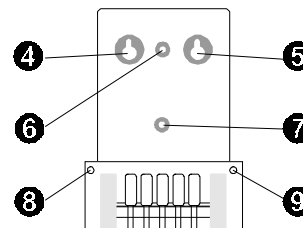

### Antennae

Dual 9-inch (23 cm) wire whip antennae ( ❶ ) come with the RMX-1R Receiver. An optional remote antenna (RM-1E) may be purchased separately to improve operating range.

### Controller Connection

The controller cable connection ( ❷ ) links the receiver to the controller.

## INSTALLATION

### Decide on Location for Receiver

You may install the RMX-1R Receiver either indoors or outdoors. Indoor installation provides better security for the receiver, while outdoor installation typically results in better reception.

Regardless of the installation you choose:

- Keep the receiver and antenna away from RF sources such as motors, fans, and other devices that may cause interference.

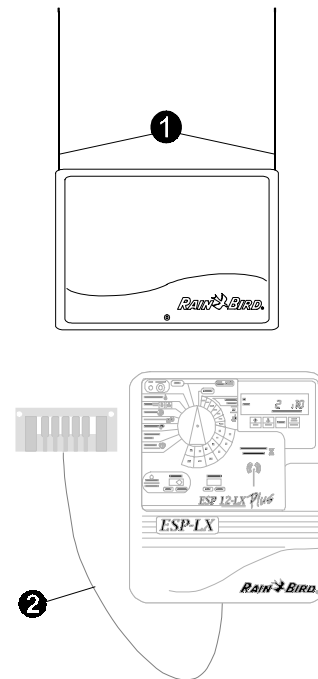

RMX-1R Receiver

- When using the dual local whip antennae, DO NOT install the receiver near metal objects, which can shield the signal and decrease radio range.
- DO NOT splice additional wire into the line. Wire splices add noise to the line.
- Construction materials such as concrete, brick, steel reinforcements, and plaster can decrease the radio range.
- Place the RMX-1R as high above ground level as possible.
- The RMX-1R comes with a standard 36" (92 cm) cable. If you need to position the receiver more than 36" (92 cm) from the controller, use a Rain Bird Remote Control Extra Length cable with bracket (EXB), which will allow you to place the receiver up to 30' (9 m) from the controller.

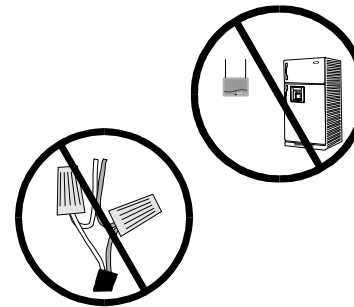

Wallboard & wood studs

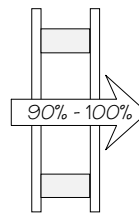

Light concrete or brick

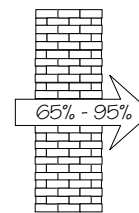

Steel-reinforced concrete or metal lath & plaster

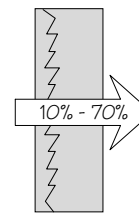

### Mount the RMX-1R

- 1 Position the bracket at about eye level, or as high above ground level as possible. If you need to position the receiver more than 36" (92 cm) from the controller, use a Rain Bird Remote Control Extra Cable Length with bracket (EXB), which will allow you to place the receiver up to 30' (9 m) from the controller.

Leave about 6" (15 cm) of space above the bracket to slide the receiver down over the bracket guides.

- 2 The RMX-1R Receiver can be mounted on either a flat surface or a narrow post or exposed wall stud. Mark the locations of the mounting holes as shown in the illustrations.
- 3 For a flat-surface installation, drive two fasteners into the upper marks. Leave about 1/4" (6 mm) of the screw exposed. The mounting points are sized for a #8 self tapping screw; however, use the appropriate type of fasteners for your surface.

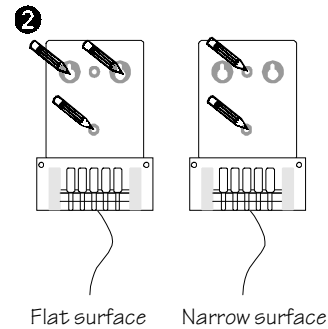
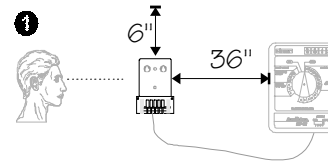

RMX-1R Receiver



- 4 On a flat surface, hang the bracket on the fasteners. Tighten down the upper fasteners. Then drive a fastener into the lower mark.
- 5 For a narrow surface, position the bracket over the marks and drive in two fasteners.
- 6 Using the guides on the back of the receiver, slide the receiver down onto the bracket until the connection is complete.

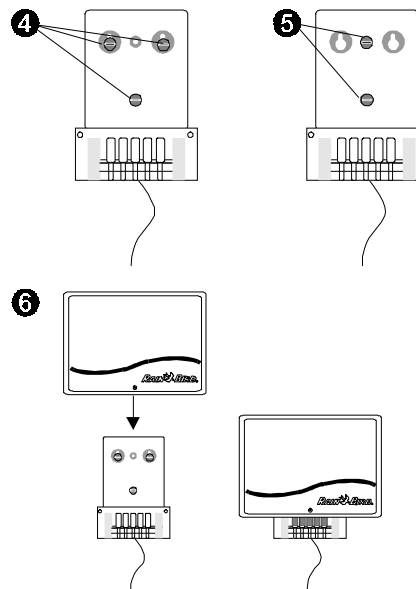

### Connect Receiver Cable to Controller

- 1 Open the front door of the controller.
- 2 Open the face panel of the controller. Refer to the drawing for the remote-ready Rain Bird controller you are using.
- 3 Run the cable from the RMX-1R through the wiring opening in the controller case to the controller connector.  
On the ESP-Si, route the cable through the notch provided in the wiring skirt.  
On the ESP-LX+, route the cable through the battery holder.  
Align the pins on the connectors and plug the cable in.

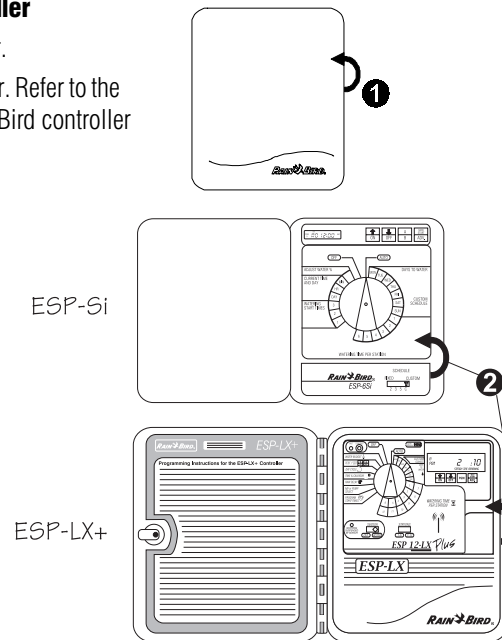

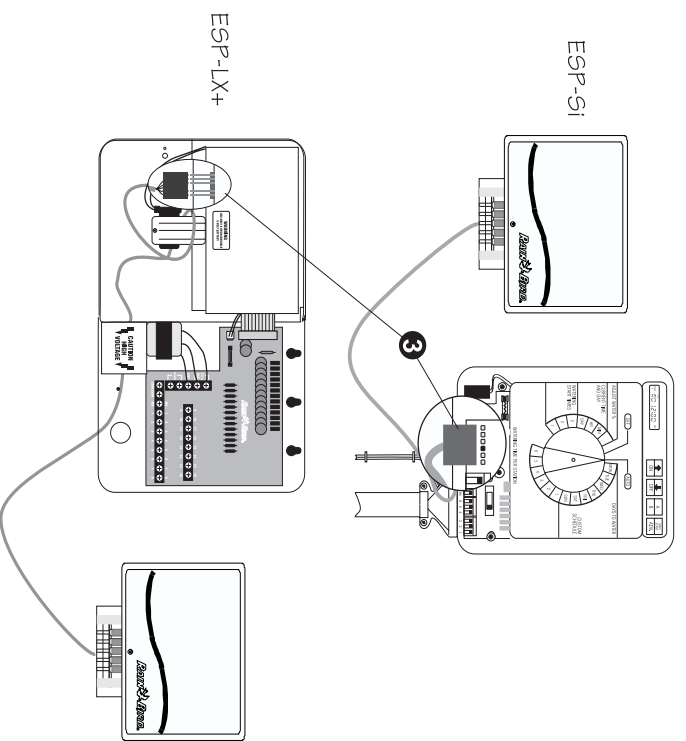

RMX-1R Receiver

Page 11

### Connect Antennae

- 1 If you are using the dual whip antennae, remove the access screw from the cover. Then remove the cover from the receiver.

**NOTE:** If you are using a remote antenna, see the directions supplied with the antenna (RM-1E).

- 2 Loosen the screw terminals for the antennae. Then install the two antennae under the left and right antenna terminals. Align the antennae in the cabinet slots.

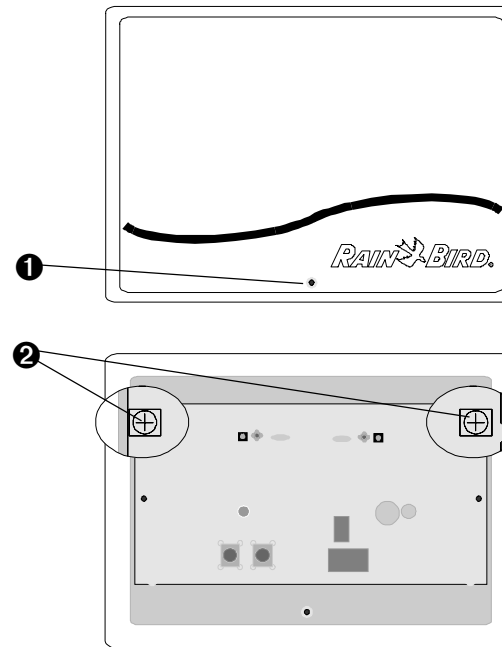

- ③ Make sure the antennae tips are below the screw and under the terminal plate. Tighten the screws on the terminals.

If you wish to register a transmitter with the RMX-1R Receiver, leave the front cover off. Otherwise, place the cover on the front of the receiver, and re-install the access screw.

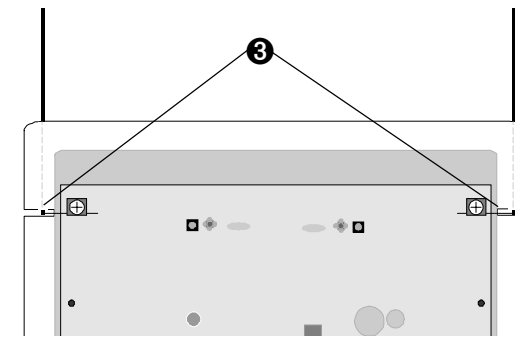

### REGISTERING TRANSMITTERS

See your transmitter manual for directions on registering a transmitter in the RMX-1R's memory.

### CHECK RECEIVER'S MEMORY

The RMX-1R receiver can store codes for up to 16 transmitters. Follow these steps if you want to find out how many transmitter codes are stored in the RMX-1R's memory.

- 1 Remove the lower screw and remove the receiver's cover.
- 2 Press and hold the Channel 1 button until the indicator LED lights up.
- 3 Release the button.
- 4 Count the number of times the LED blinks. The number of blinks is equal to the number of transmitters currently registered in the receiver.

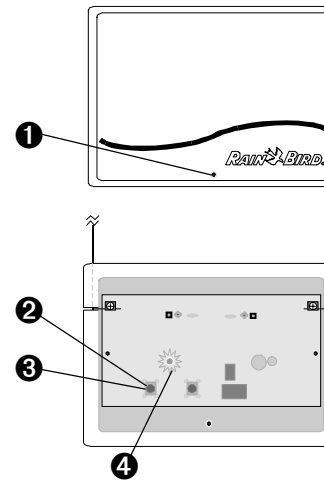

### ERASE RECEIVER'S MEMORY

You may need to erase the receiver's memory to remove codes for transmitters you no longer want to work with the receiver.

- ⑤ After removing the receiver's cover, press the Channel 1 button and hold it down until the indicator light blinks one time for each transmitter currently registered.
- ⑥ After the final blink, continue holding the button down for a count of 5. The light will blink once more, indicating that memory has been erased. Release the Channel 1 button.

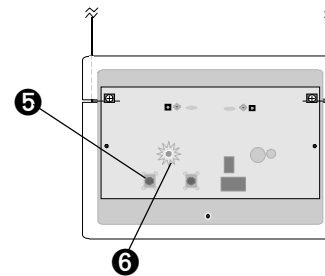

**CANADA: Complies with IC RSS-210; en  
conformité avec IC: CNR-210: 1078 102  
1859A5 3**

This device complies with FCC Part 15 and IC  
Rules and Regulations. Operation is subject to the

following two conditions: (1) This device may not  
cause harmful interference, and (2) This device  
must accept any interference received, including  
interference that may cause undesired operation.



145 North Grand Avenue, Glendora, California 91740, U.S.A. 626-963-9311

© 2000 Rain Bird Sprinkler Mfg. Corp.

® Registered trademark of Rain Bird Sprinkler Mfg. Corp.

**Technical Services: 800-247-3782**

**<http://www.rainbird.com>**

*P/N 634260A*