

SMARTWIRE™

2-Wire System Owner's Manual

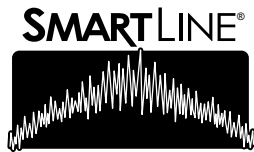

[www. SMARTLINE .com](http://www.SMARTLINE.com)

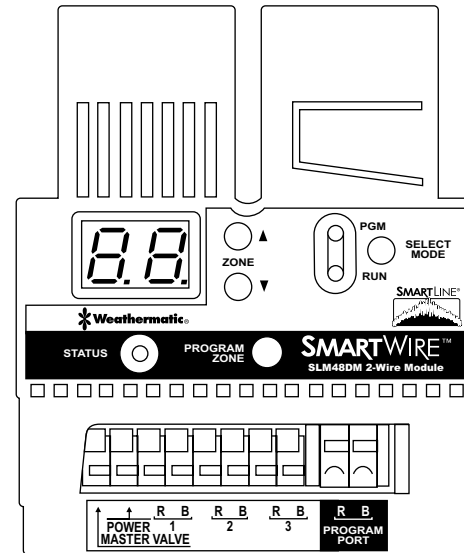

Contents

1.1 System Components 3

1.2 How It Works 3

1.3 Installing the SLM48DM 2-Wire Decoder Module..... 4

1.4 Programming the Decoders 4

1.5 Planning Your 2-Wire Layout 6

1.6 Lightning Protection 8

1.7 Troubleshooting 11

1.8 Special System Features 12

1.9 Electrical Specifications 12

**SMARTWIRE™ SLM48DM 48-zone
2-wire decoder module**

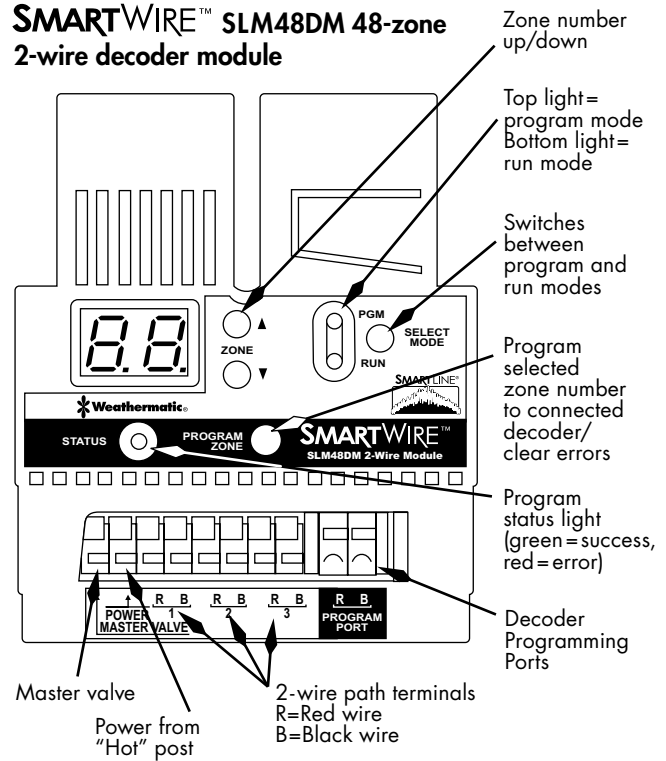

1.1 System Components

SLM48DM	48-zone 2-wire decoder module
SLDEC1	Single-zone decoder
SLDEC2	Two-zone decoder
SLDEC4	Four-zone decoder
SLGDT	Lightning arrestor for surge protection
SLCAM	Clamp-on Amp Meter
SLCONN	Specialty Wire Connector
SLWIRE	2-conductor, jacketed UL/UF approved for direct burial

1.2 How it Works

A decoder is installed at each valve box to activate the valves. Each decoder has a unique address which identifies it to the Weathermatic SLM48DM 2-wire programming module installed in any SL1600 SmartLine® controller. The SLM48DM 2-wire decoder module broadcasts a command to activate on a certain address. All the decoders on the 2-wire system “decode” the message but only the appropriate decoder responds and turns the attached valve on or off. The decoder responds back to the decoder module with a status message.

The advantages of a SmartWire™ system include cost savings from reduction in copper wire usage and corresponding trenching, simplicity of wiring and troubleshooting and ease of expansion when additional zones are needed. Weathermatic SmartWire™ 2-Wire allows for connection of up to 3 separate 2-wire paths to simplify installation on larger projects. SmartWire™ is a member of the SmartLine® family of water management products offering automated, on-site water management.

1.3 Installing the SLM48DM 2-Wire Decoder Module

The SLM48DM 2-Wire Decoder Module permits use of any SL1600 controller for 2-wire installation. The SL1600 will display 48 programmable zones when the SLM48DM is installed. You cannot exceed a total of 48 zones.

- Step 1: Turn off the power to the SmartLine® Controller.
- Step 2: Remove any previously installed zone modules and insert the SLM48DM into the far left side module slots in your controller.
- Step 3: Disconnect the transformer’s green grounding wire from the terminal strip and cover exposed wire with a wire nut. This step is REQUIRED for SmartWire lightning protection to work properly.
- Step 4: Connect the provided power wire from the Power terminal on the SLM48DM to the controller Hot Post.
- Step 5 (optional): If you are using a master valve or pump start relay, and it is more convenient to wire to these devices at a location not near the controller, you can connect a wire (provided) from the master valve terminal on the SLM48DM to the P/MV terminal on the SL1600 controller as shown in the illustration. If you choose this method of wiring, you will need to program a decoder as Zone 99 for use with the pump start relay or master valve. If it is convenient to wire the devices directly to the P/MV terminal on the controller, no wire link is needed between the P/MV terminal and SLM48DM.
- Step 6: Re-connect power to the controller. You are ready to program your decoders. The SLM48DM will perform a “power-up self test” at initial power-up. The power-up self test will confirm the integrity of the processor and will test the display and all LEDs to make sure they are working. A successful test will terminate with two dashes “--” in the display.

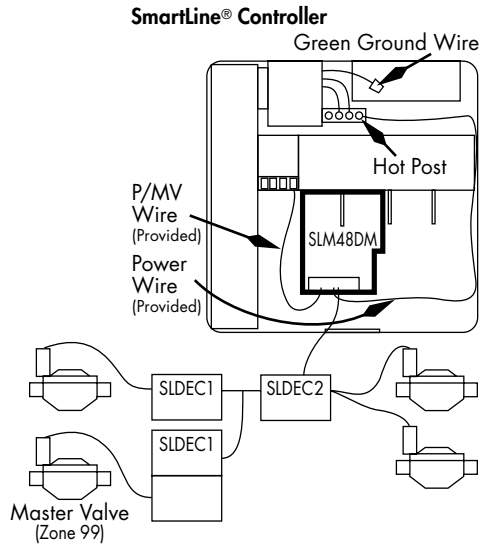

1.4 Programming the Decoders

Step 1: Map out your valve and decoder locations. See Section 1.5.

Step 2: Program all your decoders at the SmartLine® controller. You will need to mark each decoder with a pen (included) to record the zone number assigned to each valve. Note the adjacent chart of valve wire colors for each decoder:

- Each decoder will have RED and BLACK wires. These are the wires that will connect to the 2-wire path. The RED and BLACK are also the wires that you will insert in the Programming Ports on the SLM48DM to program the decoder.

1-Valve Decoder

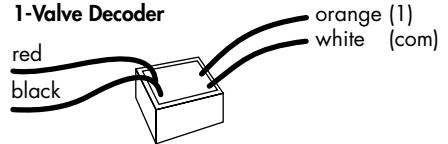

2-Valve Decoder

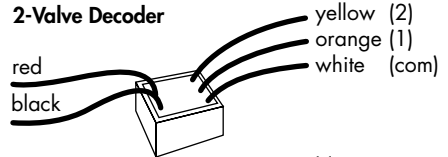

4-Valve Decoder

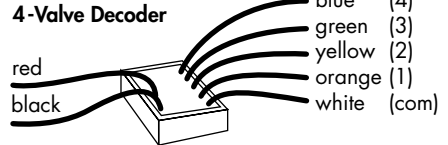

1-Valve Decoder: WHITE wire for the common and ORANGE wire for valve one.

2-Valve Decoder: Common is WHITE; ORANGE is valve one and YELLOW is valve two.

4-Valve Decoder: Common is WHITE; ORANGE is valve one; YELLOW is valve two; GREEN is valve three and BLUE is valve four.

Decoder Programming Steps:

- Use the SLM48DM mode button to select the PGM programming position.
- Insert the RED and BLACK wires on the decoder in the Programming Ports on the SLM48DM (RED to RED, BLACK to BLACK).
- Use up/down arrow buttons to select the zone number to be programmed.
- Push Program Zone button to select the zone showing in the display window. Note: When you are programming a multi-valve decoder, the display will only show the zone number for the first zone to be assigned to that decoder. **The remaining zones in the decoder are automatically assigned in sequential numerical order.**
- A GREEN status light will confirm your selection.
- If programming is not successful, a RED status light will flash and an error code will be shown on the display. See Troubleshooting for description of error codes.
- Mark the zone number programmed on the decoder. Note: If you are using a multi-valve decoder, the decoder will record the zone selected in the order previously noted for wire colors. For example, if you are using the 4-valve decoder, the first zone programmed will be Orange, the second Yellow and so on. Mark the zone number on the decoder for reference during field installation. You should also mark all zone numbers on your valve layout plan for reference during installation of the decoders.
- After the decoders are connected to the valves, use the Mode button on the SLM48DM to place the decoder programmer in the Run position. The Green status light will confirm that the system is ready for operation. If the light is Red, refer to the Troubleshooting guide.
- If you are using a master valve on your system, be sure to program it as zone 99 in the SLM48DM using a 1-valve decoder.

SLM48DM RUN Mode

- The program status LED will be GREEN.
- After a program is complete, the SLM48DM display will show any malfunctioning zones. If more than one zone is malfunctioning, each zone along with the corresponding error code will be displayed sequentially in a repeating loop. The Program Zone button will clear each error code as it is displayed. See Troubleshooting for fault code descriptions.

Programming Zones on your SmartLine® Controller

After the 2-wire installation and decoder programming is complete, you can use the SmartLine® controller to establish the watering schedule for all zones. The normal SL1600 programming convention applies to the SmartWire™ system.

1.5 Planning Your 2-Wire Layout

The SmartWire™ SLM48DM 2-Wire Decoder Module allows you to have several options in cable routing to determine the most efficient 2-wire layout for your project. You can connect as many as three 2-wire runs. Maximum decoder to valve distance is 100 feet (30.5m).

Each 2-wire run can be laid out in Straight Run, Complete Loop, Star, or Combination configurations as shown to the right.

It is suggested that a continuous loop be laid out around the site. This usually follows the main water lines. The loop will start at the Smart-Line® controller and continue around the site and then return to the controller. This provides the best communication and power path for the system. The loop provides a redundant path for the power and signal allowing the system to continue operation if the loop is cut.

Branches can come off the main loop and they do not need to be looped back to the main trunk line. These branches can be other loops, stars or single dead-end lines. The system will work with most wiring configurations if the wire length requirements are met. (Note: Keep BLACK to BLACK and RED to RED when wiring the communication wire.)

Attaching Components

- Twist wires together and secure with the SLCONN metal block wire connector.
- Encapsulate the metal block inside the 3M DBR type, grease filled waterproof connector. Use of a connector is required for all connections between the 2-wire path and the decoders.
- Use the appropriate connector for the wire size being used.
- Adhere to all local and national building and electrical codes.

Suggested Wire Details

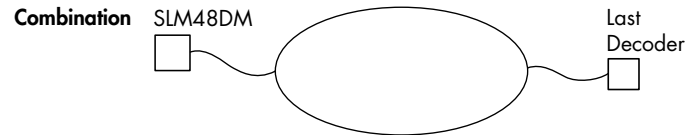
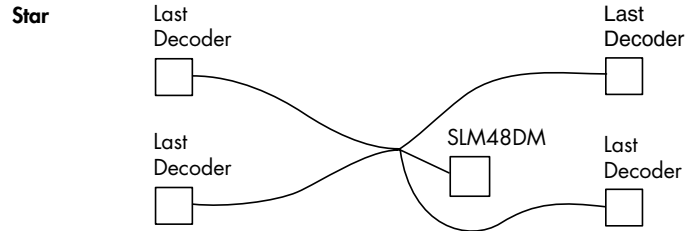
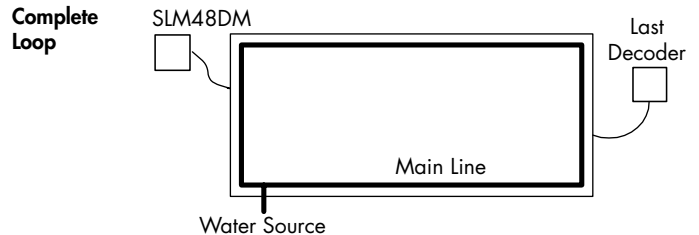
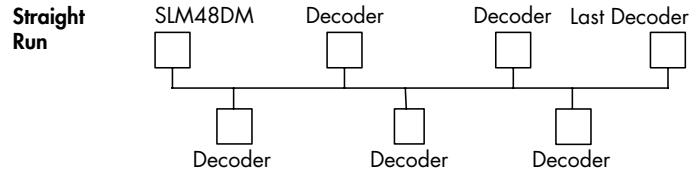

Wiring Sizes

Straight line configuration, i.e. wire distance to the furthest decoder, no loop:

Wire Size (Gauge)	#18	#16	#14	#12
Wire Length (ft)	1,000	2,000	4,000	6,000
Wire Length (m)	305	610	1,210	1,829

Loop configuration, i.e. wire distance to the furthest decoder in the loop:

Wire Size (Gauge)	#18	#16	#14	#12
Wire Length (ft)	2,000	4,000	10,000	10,000
Wire Length (m)	610	1,210	3,048	3,048

Maximum total wire path length is 10,000 ft. (3,048 m).

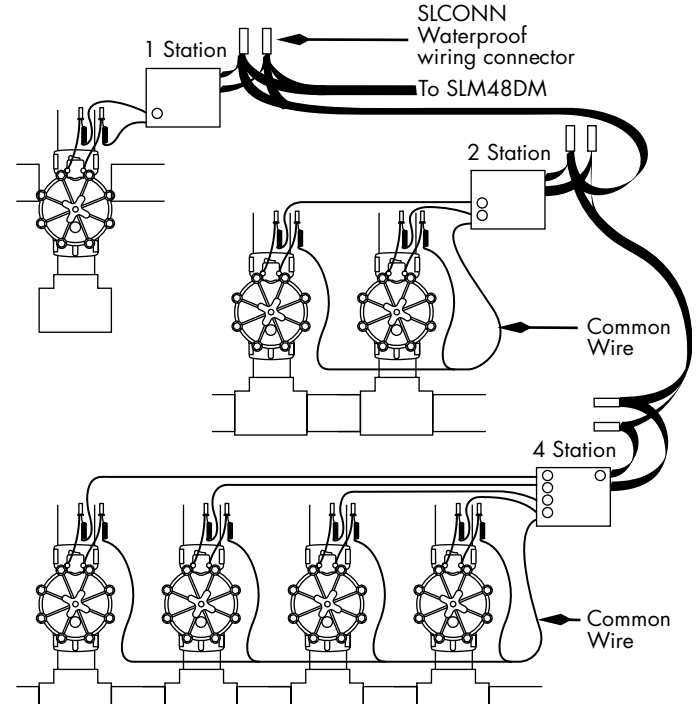
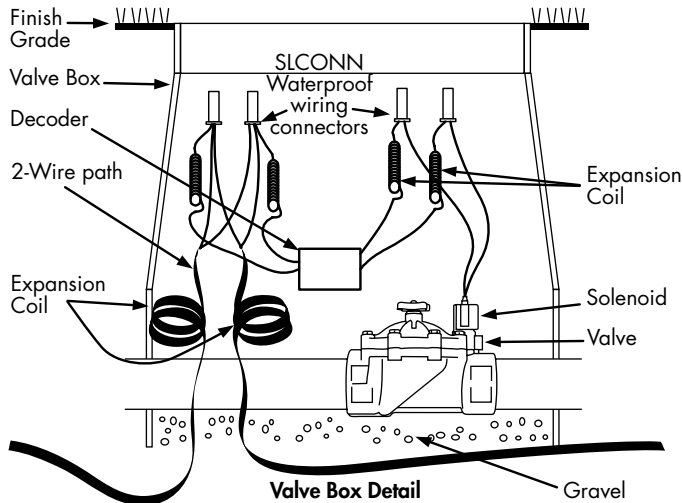

Weathermatic recommends the use of SLWIRE cable specifically designed for an irrigation control system and complying with the following specifications:

- Conductors must be soft drawn, annealed, solid copper conforming to ASTM 33.
- Conductor insulation must be 4/64-inch thick polyvinyl chloride (PVC) conforming to UL #493.
- The two insulated conductors laid in parallel and encased in a

single outer jacket of 3/64-inch thick, high-density, sunlight resistant **polyethylene** conforming to ICEA S-61-402 and NEMA WC5, having a minimum wall thickness of .045-inch.

- The two conductors must be color-coded: normally one conductor red and the other black. Both conductors shall be the same size.
- The following models meet the above specifications for direct burial cable: Weathermatic SLWIRE12; Weathermatic SLWIRE14.

1.6 Lightning Protection

Weathermatic SLGDT gas discharge tube lightning arrestors must be used on all 2-wire grids. The SLGDT lightning arrestor attaches directly to the 2-wire system and helps dissipate static electricity generated by a nearby lightning strike. While Weathermatic components have lightning arresting features, the SLGDT provides an extra measure of protection.

Features

- Protects the 2-wire system from excessive static charges created by a lightning strike.
- Sealed and impervious to moisture, salts, fertilizers and mild chemicals. Can be buried directly in the soil.
- Shock resistant
- Freeze/heat resistant (-20° to 60° C)
- No electrical contact with the soil
- Each Lightning Arrestor protects a 300 foot radius

SLGDT Lightning Arrestor

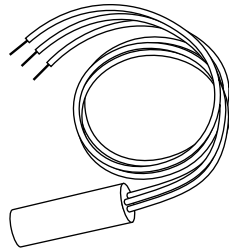

Electrical Specifications

- Requires no power from the 2-wire system
- Can only be connected to SmartWire™ 2-wire systems

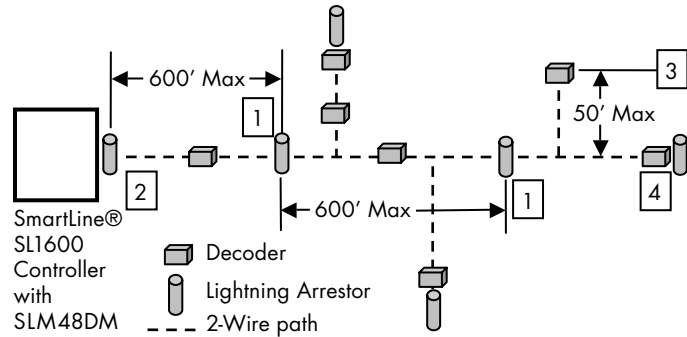

Procedures for Installation

- Connect the RED and BLACK lead wires to the 2-wire system RED and BLACK wires.
- Attach the GREEN ground wire to Earth Ground (Grounding Requirements below)
- Use only DBY or DBR 3M Type waterproof connectors encapsulating a twisted wire connection inside a metal block (SLCONN included).
- For maximum protection, place an SLGDT every 600 feet along the 2-wire system. (Example 1 in graphic above.)
- One SLGDT should be within 25 ft of the host SmartLine® controller. (Example 2 in graphic above.)
- A single stub line must not exceed 50 feet without an SLGDT lightning arrestor. (Example 3 in graphic above.)
- An SLGDT lightning arrestor must also be placed at the end of the 2-wire run that is the maximum distance from the SmartLine® controller, or if looped, at the point of maximum distance from the SmartLine® controller. (Example 4 in graphic above.)

Ground Detail #1: SLGDT with single ground rod

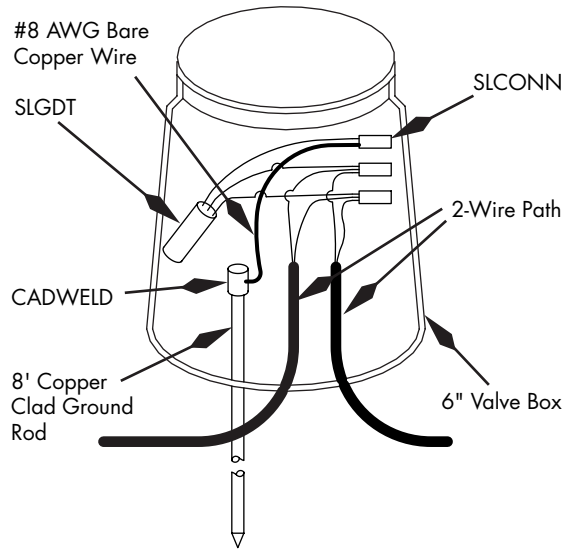

Ground Detail #2: SLGDT with Triangular Grid

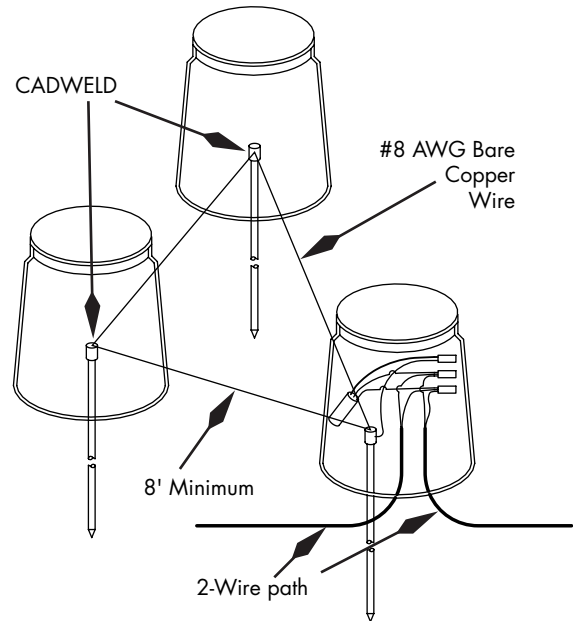

Grounding Requirements

- The GREEN ground wire must be attached to a #8 solid bare copper wire using the included SLCONN wire connector. Connect the bare ground wire to a grounding circuit with 12 Ohms or less resistance to earth ground, measured with a ground resistance meter or Megger.
- A grounding circuit is comprised of 4 major components:
 - o Ground Rod(s) and/or Plate(s).
 - o Ground Conductor.
 - o Exothermic or Cadmium Weld connections.
 - o Soil and/or Ground Enhancement Materials.
- Ground Rods/Plates must be installed in a 6" min. valve box, 6" below grade or below frost line, located within an irrigated zone to maintain soil moisture and maximum ground performance.

- Ground Rods shall be UL listed "copper clad", 5/8" minimum diameter, 8' of length, and must meet the requirements of NEC article 250-52(c).
- Ground Plates shall be a copper alloy specifically intended for grounding, with a minimum thickness of 0.060". Each plate shall expose a minimum of 5 square feet of surface area to contact the soil, and meet the requirements of NEC article 250-52(d).
- Grounding Conductor shall be a solid, bare copper wire or strap used to connect the green ground wire to the ground rod or plate, sized appropriately to achieve specified resistance.

Ground Detail #3: Ground Rod with GEM

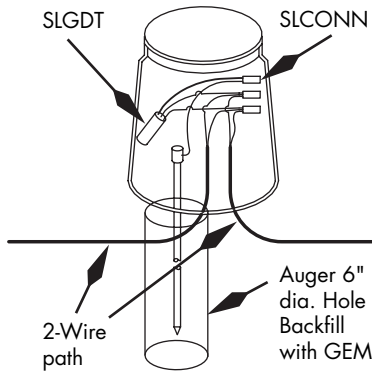

Ground Detail #4: Ground Rod and Plate with GEM

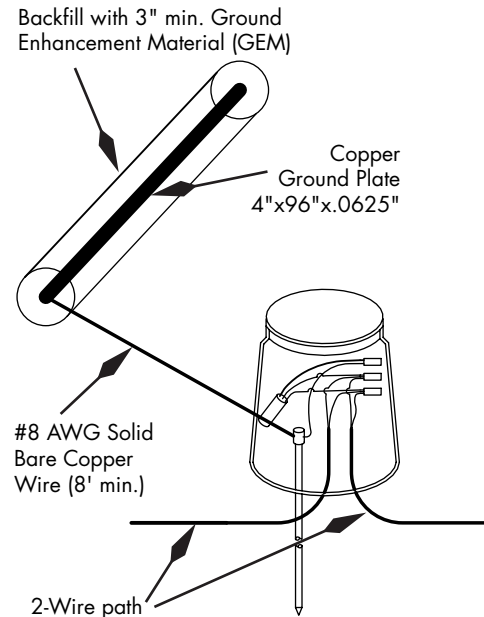

- Exothermic or Cadmium Weld products such as CADWELD One Shot ®, shall be used to connect the #8 AWG bare copper ground conductor to the ground rod or plate.
- Ground Enhancement Materials such as Powerset®, PowerFill®, and GEM® shall be used as required to achieve specified resistance to earth ground.
- Local soil and site conditions will dictate what extent of grounding measures will be required. Generally there are 3 soil types that each require different methods and equipment to achieve the 12 Ohm minimum resistance to ground:
 - o Clay soils: A single ground rod is typically sufficient, located in an irrigated zone, with CADWELD connections and no soil amendments. Some sites require a 6” diameter hole to be augered and backfilled with Ground Enhancement Materials.
 - o Loam Soils: Typically a 3-ground rod grid is required, located in an irrigated zone, with CADWELD connections, 6” augured holes and Ground Enhancement Material as required.
 - o Sandy soils: Require the most extensive ground circuits which require combinations of ground rods, plates, CADWELD connections

- and ground enhancement materials, located in an irrigated zone.
- Any combination of the above recommendations should be considered to achieve 12 Ohms or less. Long-term maintenance of any ground system requires that it be located within an irrigated or wetted zone.
- Refer to www.erico.com for a complete line of grounding equipment and materials.
- Refer to www.asic.org/design_guides.htm for American Society of Irrigation Consultants (ASIC) Guideline 100-2002 For Earth Grounding Electronic Equipment in Irrigation Systems.

1.7 Troubleshooting

The SLM48DM provides special key combinations that can be used to access special features and information that can be helpful during the diagnostic process. These key combinations are as follows:

- o Push Up Arrow and Down Arrow simultaneously to view the software version for your SLM48DM.
- o Push Select Mode and Up Arrow buttons simultaneously, then release and use Up and Down Arrows to select a zone, then push the Program Zone button to view the software version for that particular decoder.
- o Hold down Select Mode button for 5 seconds and release to initiate a quick test of all zones. When using the test mode, zone addresses will be displayed while the zone is operating. If multiple zones are operating, the zone addresses will be displayed rotating every three seconds until the zone is turned off.
- o Push Program Zone and Up Arrow simultaneously to view the SLM48DM temperature.

If an over current or over temperature is sensed by the SLM48DM decoder programmer, it will cause a FAULT message to appear on the display of the SmartLine[®] controller. Open the SmartLine[®] panel and check the FAULT on the display of the SLM48DM decoder programmer. After the FAULT is repaired, press the Program Zone button on the SLM48DM to clear the error message. Refer to the table below for SLM48DM error messages and corresponding corrective actions.

- Decoder Locating: To use a 521 locator to find a decoder, the decoder should be turned on by the controller and located using the 521 wand (patent pending).
- Valve Locating: Use the SL1600 controller Advanced Functions menu options for the valve locator to find the valve. This feature will create a "chatter" for a selected valve as a convenient method of locating buried valves. Use NEXT and BACK buttons to scroll to the valve you want to "chatter."

Fault Code	Description	Cause/Action
E1	No decoder found	Cause: wiring error, defective decoder, defective SLM48DM programmer. Action: check wiring, move decoder closer to the SLM48DM, replace.
E2	2-wire over current	Cause: shorted wiring, wire connected to dirt, improper connections, failed decoder (shorted), valve connected directly to 2-wire. Action: troubleshoot wiring problems by undoing the last thing you did when it worked before, and/or by breaking the 2-wire system in half to isolate the problem, then in half again as needed.
E3	Open circuit at solenoid	Cause: the decoder detects no solenoid current when activated: open solenoid, poor connections/wiring between decoder and solenoid, broken decoder. Action: check decoder to solenoid connections, ohm solenoid, replace solenoid, replace decoder.
E4	Short Circuit at solenoid	Cause: poor quality wiring between SLM-48DM and decoder (length, connections, high resistance, 2-wire connected to dirt), failing decoder, failing SLM48DM (gives errors on "all" decoders), multiple decoders with same address. Action: test 2-wire quality (end-to-end resistance, resistance to earth ground, isolate decoder in error (test close to decoder manager), check for duplicate addresses.

1.7 Troubleshooting Continued

Fault Code	Description	Cause/Action
E5	Decoder Communication Error	<p>Cause: poor quality wiring between SLM-48DM and decoder (length, connections, high resistance, 2-wire connected to dirt), failing decoder, failing SLM48DM (gives errors on "all" decoders), multiple decoders with same address.</p> <p>Action: test 2-wire quality (end-to-end resistance, resistance to earth ground, isolate decoder in error (test close to decoder manager), check for duplicate addresses.</p>
E6	High Temperature Shut Down	<p>Cause: high temperature, excessive 2-wire duty cycle at temperature.</p> <p>Action: shade controller, replace SLM48DM.</p>
E7	Decoder Programming Failure	<p>Cause: multiple decoders at one time, decoder removed before program cycle completes, failed decoder, failing SLM48DM.</p> <p>Action: retry, replace decoder, replace SLM48DM.</p>

1.8 Special System Features

- A unique address is configured in each decoder during the configuration process.
- Valves are actuated by a command from the decoder.
- Diagnostic features—The SLM48DM reports failing solenoids.
- If a solenoid has failed, the decoder senses an open circuit and/or over current condition and shuts down the valve.
- Each decoder will shut down if communication is lost to the SLM-48DM decoder module in the SmartLine® controller.
- Valves can be located up to 100 feet from the decoder.
- Decoder electronics are potted in chemical and waterproof compounds for impervious protection from moisture and dirt.

1.9 Electrical Specifications

- Input voltage 24 - 28 VAC over the 2-wire system.
- The Weathermatic SLM48DM can support a total of 48 valves plus a master valve. A maximum of 3 valves including master valve or pump relay can be operated concurrently.
- No electrical contact with soil.
- Shock resistant.
- Freeze/heat resistant (-20° to 60° C).
- All connecting wires are 14 gauge coated PVC and must be installed with industry standard waterproof connectors such as the 3M DBY or DBR.



www.SMARTLINE.com

